

## What's inside...

Carefully curated products for protecting and safely storing a vast array of archival collection materials.

|  |       |
|--|-------|
| Document Storage .....                 | 2-6   |
| Primary Enclosures .....               | 7-12  |
| Pamphlet Storage .....                 | 13-15 |
| Preservation Supplies.....             | 16-18 |
| Photographic Supplies & Equipment..... | 19-27 |
| Specialty Storage .....                | 28-33 |
| Cabinets.....                          | 34    |



All products labelled **SafePack** are packaged in **acid-free** shrink wrap to preserve archival integrity and protect against dust, dirt, moisture, and fingerprints.

### Specifications

- 60-pt. barrier board
- Acid-free, lignin-free
- 8.0-9.0 pH
- Grey/white, tan, or black
- 3% calcium carbonate buffer
- P. A.T. Certified



### Document Cases

Designed for long-term storage

- Exposed serrated edge to reduce chance of injury
- Shrink-wrapped with polyethylene to preserve archival integrity
- One-piece scuff-resistant cases feature a hinged lid for quick and easy access to materials
- Metal-reinforced edges add stacking strength and durability
- All cases feature a pull string for easy removal from storage shelf
- Choose from standard or extra-deep cases

SafePack

#### GREY/WHITE DOCUMENT CASES

| CAT.#      | H x W x D                  | LBS. | PRICE   | 10+     |
|------------|----------------------------|------|---------|---------|
| 38 362 001 | 10 3/4" x 12 3/4" x 2 1/2" | 0.60 | \$22.60 | \$21.47 |
| 38 362 002 | 10 3/4" x 12 3/4" x 5"     | 0.80 | 23.55   | 22.38   |
| 38 362 003 | 10 3/4" x 15 3/4" x 2 1/2" | 0.70 | 23.62   | 22.44   |
| 38 362 004 | 10 3/4" x 15 3/4" x 5"     | 0.90 | 24.11   | 22.91   |
| 38 362 005 | 12 1/2" x 15 3/4" x 5"     | 2.10 | 35.79   | 34.00   |

#### TAN DOCUMENT CASES

| CAT.#      | H x W x D                  | LBS. | PRICE   | 10+     |
|------------|----------------------------|------|---------|---------|
| 38 363 001 | 10 3/4" x 12 3/4" x 2 1/2" | 0.60 | \$26.68 | \$25.35 |
| 38 363 002 | 10 3/4" x 12 3/4" x 5"     | 0.80 | 27.31   | 25.95   |
| 38 363 005 | 12 1/2" x 15 3/4" x 5"     | 2.10 | 42.95   | 40.80   |

#### BLACK DOCUMENT CASE

| CAT.#      | H x W x D              | LBS. | PRICE   | 10+     |
|------------|------------------------|------|---------|---------|
| 38 367 002 | 10 3/4" x 12 3/4" x 5" | 0.80 | \$31.09 | \$29.54 |

#### EXTRA-DEEP GREY/WHITE DOCUMENT CASES

| CAT.#      | DESCRIPTION | H x W x D              | LBS. | PRICE   |
|------------|-------------|------------------------|------|---------|
| 38 368 001 | Letter      | 10 3/4" x 12 3/4" x 7" | 1.00 | \$33.44 |
| 38 368 002 | Legal       | 10 3/4" x 15 3/4" x 7" | 1.20 | 38.57   |

### Specifications

- 50-pt. barrier board
- Acid-free, lignin-free
- 8.0-9.0 pH
- Grey/white or tan
- 3% calcium carbonate buffer
- P. A.T. Certified

### Tyvek® Laminated Document Storage Cases

Superior flex-fold strength

- Exposed serrated edge to reduce chance of injury
- Shrink-wrapped with polyethylene to preserve archival integrity
- Constructed of 50-pt. barrier board covered with archival-safe Tyvek® laminate
- Excellent tear- and water-resistant properties
- Resist mildew and rot, remain pH-neutral, and are fully recyclable

SafePack

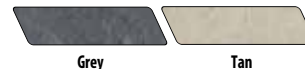

#### GREY/WHITE LAMINATED CASES

| CAT.#      | H x W x D                  | LBS. | PRICE   | 10+     |
|------------|----------------------------|------|---------|---------|
| 38 362 101 | 10 3/4" x 12 3/4" x 2 1/2" | 0.60 | \$36.82 | \$34.98 |
| 38 362 102 | 10 3/4" x 12 3/4" x 5"     | 0.80 | 38.04   | 36.14   |
| 38 362 103 | 10 3/4" x 15 3/4" x 2 1/2" | 0.70 | 38.07   | 36.17   |
| 38 362 104 | 10 3/4" x 15 3/4" x 5"     | 0.90 | 41.07   | 39.02   |
| 38 368 102 | 10 3/4" x 15 3/4" x 7"     | 1.20 | 66.52   | 63.20   |

#### TAN LAMINATED CASE

| CAT.#      | H x W x D              | LBS. | PRICE   | 10+     |
|------------|------------------------|------|---------|---------|
| 38 363 104 | 10 3/4" x 15 3/4" x 5" | 0.90 | \$44.41 | \$42.19 |

## Specifications

- B-flute grey stone corrugated board
- Acid-free, lignin-free
- 8.0-9.0 pH
- 3% calcium carbonate buffer
- P.A.T. Certified



## Document Cases

Designed for economical long-term storage

- Flip-top lid keeps documents free from dust, dirt, and fingerprints, yet allows quick access
- Locking tabs on each side keep lid shut when not in use
- Choose acrylic-coated board that repels moisture, or uncoated
- Cases ship flat and ready to assemble

### ACRYLIC COATED

| CAT.#      | H x W x D              | LBS. | PRICE   | 10+     |
|------------|------------------------|------|---------|---------|
| 49 546 002 | 10 1/2" x 12 1/2" x 5" | 0.50 | \$21.51 | \$20.44 |
| 49 546 004 | 10 1/2" x 15 1/2" x 5" | 0.70 | 25.07   | 23.82   |

### UNCOATED

| CAT.#      | H x W x D                  | LBS. | PRICE   | 10+     |
|------------|----------------------------|------|---------|---------|
| 49 546 101 | 10 1/2" x 12 1/2" x 2 1/2" | 0.40 | \$16.52 | \$15.69 |
| 49 546 102 | 10 1/2" x 12 1/2" x 5"     | 0.50 | 23.20   | 22.04   |
| 49 546 105 | 12 1/2" x 15 1/2" x 5"     | 1.00 | 25.61   | 24.33   |

## Specifications

- 3-mil copolymer of polypropylene and polyethylene
- pH-neutral
- Chemically stable

## Coroplast™ Document Case

Rigid stacking strength; washable

- One-piece corrugated plastic case
  - Resists heat and moisture
- Ships flat and ready to assemble.



| CAT.#      | H x W x D              | LBS. | PRICE   | 10+     |
|------------|------------------------|------|---------|---------|
| 49 475 002 | 10 1/2" x 15 1/2" x 5" | 0.80 | \$28.63 | \$27.20 |

## Document Carton Dividers



Rigid dividers can also be used as temporary "file out" cards

- White, acid-free corrugated dividers are pH-neutral
- 1/3 cut to sort and identify stored materials
- 15 dividers per package (1.00 lb.)

| CAT.#      | DESCRIPTION | H x W             | PRICE   |
|------------|-------------|-------------------|---------|
| 49 455 001 | Letter      | 10 1/2" x 12 1/2" | \$28.47 |
| 49 455 002 | Legal       | 10 1/2" x 15 1/2" | 30.17   |

## Document Support Spacers

Pre-scored to adjust easily to document

- Acid-free, corrugated board spacers are pH-neutral
- Grey spacers are P.A.T. Certified
- Keep materials upright to prevent damage and curling during storage (0.20 lb.)



| CAT.#      | DESCRIPTION | H x W            | PRICE  |
|------------|-------------|------------------|--------|
| 49 454 002 | White Legal | 9 1/2" x 30 1/2" | \$8.51 |
| 49 160 001 | Grey Letter | 8" x 20"         | 3.92   |
| 49 160 002 | Grey Legal  | 9 1/2" x 30 1/2" | 4.50   |



### Corrugated Storage Carton

Accommodates letters or legal-size file folders  
 • **Acid-free** heavy-duty unbuffered corrugated box; has pH of 7.2  
 Ships flat and ready to assemble.

| CAT.#      | H x W x D       | LBS. | PRICE   | 10+     |
|------------|-----------------|------|---------|---------|
| 49 540 001 | 10" x 12" x 15" | 1.28 | \$19.39 | \$18.42 |



### No-Fold Storage Box with Lid

Double-walled box slides together in seconds, holds both letter- and legal-size documents  
 • Box and lid are constructed of heavy-duty corrugated board  
 Ships flat and ready to assemble.

| CAT.#      | H x W x D          | LBS. | PRICE  | 10+ |
|------------|--------------------|------|--------|-----|
| 52 747 001 | 10½" x 16½" x 12½" | 1.75 | \$7.14 |     |



### Specifications

- Corrugated board
- Acid-free, lignin-free
- P.A.T. Certified

### Storage Carton File Supports

Supports are designed to keep file folders upright in partially filled boxes  
 upright in partially filled boxes  
 • Supports adjust to two depths to support 1/3 or 2/3 full boxes  
 • Reusable supports are shipped flat  
 • Five per package

| CAT.#      | DESCRIPTION | COLOUR             | LBS. | PRICE   | 10+ |
|------------|-------------|--------------------|------|---------|-----|
| 38 013 001 | Letter-Size | B-Flute Grey-Stone | 2.30 | \$31.39 |     |
| 38 013 002 | Legal-Size  | White              | 2.50 | 23.41   |     |

### Specifications

- 3-mil copolymer of polypropylene and polyethylene
- pH-neutral
- Chemically stable

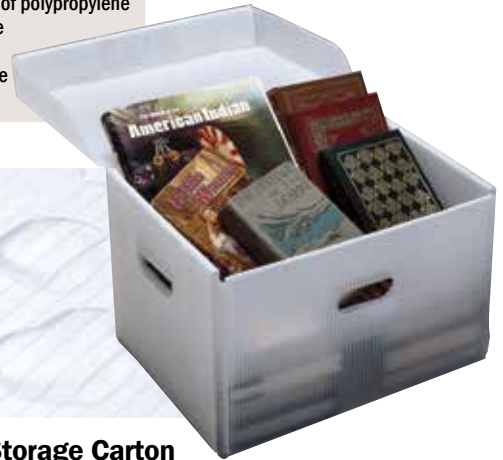

### Coroplast™ Storage Carton

Clear plastic storage carton offers rigid stacking strength  
 • Resists heat, repels water, and is washable  
 Ships flat and ready to assemble.

| CAT.#      | H x W x D       | LBS. | PRICE   | 10+     |
|------------|-----------------|------|---------|---------|
| 49 475 003 | 10" x 15" x 12" | 1.81 | \$40.31 | \$38.29 |

**Prices subject to change; please see [www.brodart.ca](http://www.brodart.ca) for up-to-date prices.**



### Specifications

- White corrugated board
- Acid-free, lignin-free
- 8.0-9.0 pH
- 3% calcium carbonate buffer
- P.A.T. Certified

### Oversized Storage Cartons

Cartons hold up to 275 lbs. and offer superior strength for handling and stacking  
 • Each carton features a shallow lid and hand cut-outs for easy transport  
 Ships flat and ready to assemble.

| CAT.#      | H x W x D       | LBS. | PRICE   | 10+     |
|------------|-----------------|------|---------|---------|
| 38 014 001 | 10" x 12" x 24" | 2.40 | \$50.25 | \$47.74 |
| 38 014 002 | 10" x 15" x 24" | 2.40 | 52.39   | 49.77   |

### Specifications

- B-flute grey stone corrugated board
- Acid-free, lignin-free
- 8.0-9.0 pH
- 3% calcium carbonate buffer
- P.A.T. Certified



### Storage Cartons

Choose acrylic-coated to repel moisture, or uncoated

- Cartons are constructed of heavy-duty corrugated board with shallow lids and hand cut-outs for easy transport
- All cartons ship flat and ready to assemble

#### ACRYLIC COATED

| CAT.#             | DESCRIPTION      | H x W x D        | LBS. | PRICE   | 10+     |
|-------------------|------------------|------------------|------|---------|---------|
| <b>49 548 001</b> | Full-Size        | 10" x 15" x 12"  | 1.10 | \$33.88 | \$32.19 |
| <b>49 548 002</b> | Letter Half-Size | 10" x 12½" x 6½" | 0.80 | 23.85   | 22.65   |
| <b>49 548 003</b> | Legal Half-Size  | 10" x 15½" x 6½" | 0.80 | 27.37   | 26.00   |

#### UNCOATED

| CAT.#             | DESCRIPTION      | H x W x D        | LBS. | PRICE   | 10+     |
|-------------------|------------------|------------------|------|---------|---------|
| <b>49 548 101</b> | Full-Size        | 10" x 15" x 12"  | 1.10 | \$30.41 | \$28.89 |
| <b>49 548 102</b> | Letter Half-Size | 10" x 12½" x 6½" | 0.80 | 21.54   | 20.47   |
| <b>49 548 103</b> | Legal Half-Size  | 10" x 15½" x 6½" | 0.80 | 25.60   | 24.32   |

### Specifications

- B-flute grey stone corrugated board
- Acid-free, lignin-free
- 8.0-9.0 pH
- 3% calcium carbonate buffer
- P.A.T. Certified



### Double-Wall Record Storage Box

Heavy-duty corrugated board construction with hinged lid

- Hand cut-outs for easy transport
- Ships flat and ready to assemble.

| CAT.#             | H x W x D       | LBS. | PRICE   |
|-------------------|-----------------|------|---------|
| <b>49 005 001</b> | 10" x 15" x 12" | 1.30 | \$32.08 |

**Prices subject to change; please see [www.brodart.ca](http://www.brodart.ca) for up-to-date prices.**

### Specifications

- Binders: 60-pt. barrier board
- Envelopes: 7-pt. buffered stock
- Acid-free, lignin-free
- P.A.T. Certified

### Envelope Storage Binders

All adhesives are acid-free

- Grey/white binder covers are attached with black cloth tape
- Light cream envelopes are attached with single-stitched pH-neutral cambric cloth

| CAT.#             | BINDER      | ENVELOPE   | LBS. | PRICE   | 10+     |
|-------------------|-------------|------------|------|---------|---------|
|                   | H x W       | H x W      |      |         |         |
| <b>38 425 001</b> | 10½" x 7½"  | 10" x 7"   | 3.80 | \$ 6.02 | \$ 5.72 |
| <b>38 425 002</b> | 12" x 9"    | 11½" x 8½" | 4.10 | 9.54    | 9.06    |
| <b>38 425 003</b> | 12½" x 9½"  | 12" x 9"   | 4.10 | 10.71   | 10.17   |
| <b>38 425 004</b> | 13½" x 10½" | 13" x 10"  | 4.10 | 11.97   | 11.37   |



### Newspaper Boxes

Resist mildew and rot, remain pH-neutral, fully recyclable

- Specifications**
- 60-pt. barrier board or 50-pt. Tyvek® laminated barrier board
  - Acid-free, lignin-free
  - 8.0-9.0 pH
  - Grey/white
  - 3% calcium carbonate buffer
  - P. A. T. Certified

- Safe, long-term two-piece storage boxes feature deep telescoping lids and metal-reinforced edges for stacking strength and durability
- Grey/white boxes also work well for storing posters, prints, and more
- 50-pt. Tyvek® laminated barrier board boxes provide excellent tear- and water-resistant properties, superior flex-fold strength
- Exposed serrated edge to reduce chance of injury
- Shrink-wrapped with polyethylene to preserve archival integrity

**SafePack**



**GREY/WHITE**

| CAT.#             | H x W x D        | LBS. | PRICE   | 10+     |
|-------------------|------------------|------|---------|---------|
| <b>38 361 001</b> | 3" x 20½" x 24½" | 2.70 | \$57.21 | \$54.34 |
| <b>38 361 002</b> | 2" x 15" x 22"   | 1.80 | 48.40   | 45.98   |
| <b>38 361 003</b> | 3" x 18" x 13"   | 1.90 | 47.78   | 45.50   |
| <b>38 361 004</b> | 2½" x 19" x 25"  | 2.40 | 54.28   | 51.57   |
| <b>38 361 005</b> | 3" x 23" x 31"   | 3.10 | 66.76   | 63.42   |

**GREY/WHITE TYVEK® LAMINATED**

| CAT.#             | H x W x D        | LBS. | PRICE   | 10+     |
|-------------------|------------------|------|---------|---------|
| <b>38 361 102</b> | 2" x 15" x 22"   | 1.80 | \$69.03 | \$65.58 |
| <b>38 361 104</b> | 2½" x 19" x 25"  | 2.40 | 88.00   | 83.60   |
| <b>38 361 103</b> | 3" x 18" x 13"   | 1.90 | 68.41   | 64.99   |
| <b>38 361 101</b> | 3" x 20½" x 24½" | 2.70 | 78.06   | 74.16   |

### Specifications

- 60-pt. barrier board or 50-pt. Tyvek® laminated barrier board
- Acid-free, lignin-free
- 8.0-9.0 pH
- Grey/white, tan, or black
- 3% calcium carbonate buffer
- P. A. T. Certified



### Drop-Front Boxes

Drop-front panel allows easy access to stored documents, photos, or prints

- Fully telescoping lid keeps out dust and dirt; choose from 60-pt. barrier board lid and 30-pt. clear textured polypropylene lid
- Boxes and lids both feature metal-reinforced edges for stacking strength and durability

- Tyvek® laminated 50-pt. barrier board boxes provide excellent tear- and water-resistant properties, superior flex-fold strength
- Exposed serrated edge to reduce chance of injury
- Shrink-wrapped with polyethylene to preserve archival integrity
- Resist mildew and rot; remain pH-neutral; fully recyclable

**SafePack**

*Tyvek® boxes provide superior tear and water resistance*

**GREY/WHITE TYVEK® LAMINATED**

| CAT.#             | H x W x D        | LBS. | PRICE   | 10+     |
|-------------------|------------------|------|---------|---------|
| <b>38 360 209</b> | 3" x 14½" x 18½" | 1.60 | \$55.07 | \$52.31 |

**GREY/WHITE WITH CLEAR LID**

| CAT.#             | H x W x D        | LBS. | PRICE   | 10+     |
|-------------------|------------------|------|---------|---------|
| <b>38 360 104</b> | 3" x 12½" x 9½"  | 2.00 | \$29.88 | \$28.39 |
| <b>38 360 109</b> | 3" x 14½" x 18½" | 1.60 | 55.78   | 52.99   |
| <b>38 360 108</b> | 3" x 15" x 11½"  | 2.20 | 36.77   | 34.93   |

**GREY/WHITE**

| CAT.#             | H x W x D        | LBS. | PRICE   | 10+     |
|-------------------|------------------|------|---------|---------|
| <b>38 360 004</b> | 3" x 12½" x 9½"  | 2.00 | \$30.34 | \$28.82 |
| <b>38 360 009</b> | 3" x 14½" x 18½" | 1.60 | 55.78   | 52.99   |
| <b>38 360 008</b> | 3" x 15" x 11½"  | 2.20 | 36.77   | 34.93   |
| <b>38 360 005</b> | 3" x 20½" x 16½" | 2.20 | 48.30   | 45.89   |
| <b>38 360 006</b> | 3" x 24½" x 20½" | 2.70 | 58.41   | 55.49   |

**TAN**

| CAT.#             | H x W x D        | LBS. | PRICE   | 10+     |
|-------------------|------------------|------|---------|---------|
| <b>38 350 004</b> | 3" x 12½" x 9½"  | 2.00 | \$35.47 | \$33.70 |
| <b>38 350 009</b> | 3" x 14½" x 18½" | 1.60 | 52.36   | 49.75   |
| <b>38 350 008</b> | 3" x 15" x 11½"  | 2.20 | 51.42   | 48.85   |

**BLACK**

| CAT.#             | H x W x D        | LBS. | PRICE   | 10+     |
|-------------------|------------------|------|---------|---------|
| <b>38 370 001</b> | 3" x 12½" x 9½"  | 2.00 | \$41.45 | \$39.38 |
| <b>38 370 002</b> | 3" x 14½" x 18½" | 1.60 | 62.41   | 59.29   |
| <b>38 370 003</b> | 3" x 15" x 11½"  | 2.20 | 57.08   | 54.22   |
| <b>38 370 004</b> | 3" x 20½" x 16½" | 2.20 | 64.46   | 61.24   |

## Archival Self-Seal Melinex® L-Sleeves

Super-clear sleeves are stable, inert, and will not adhere to the surface of stored photos

- Archival-safe, high-clarity polyester sleeves are sealed on one long side and one short side
- Self-sealing flaps make it easy to insert and remove materials
- Five sleeves per pack

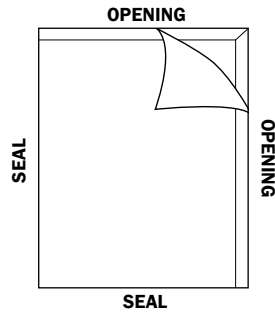

| CAT.#      | THICKNESS | FITS UP TO | LBS. | PRICE   |
|------------|-----------|------------|------|---------|
| 37 944 001 | 3-mil     | 8½" x 11"  | 0.40 | \$52.47 |
| 37 944 002 | 3-mil     | 9" x 12"   | 0.50 | 58.26   |
| 37 944 003 | 3-mil     | 11" x 14"  | 0.50 | 76.11   |
| 37 944 004 | 3-mil     | 12" x 17"  | 0.60 | 79.26   |

## Archival Melinex® L-Sleeves

L-shape makes it easy to insert and remove materials; electrostatic charge keeps contents in place

- Archival-safe Melinex® L-sleeves are high-clarity polyester sleeves that are stable, inert, and will not adhere to the surface of stored photos
- Super-clear sleeves may be sealed with double-sided tape
- 10 sleeves per pack

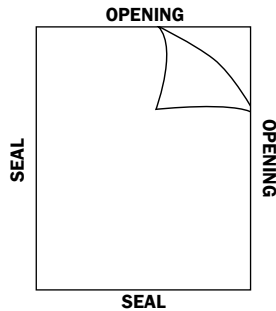

| CAT.#      | THICKNESS | FITS UP TO  | LBS. | PRICE   |
|------------|-----------|-------------|------|---------|
| 37 940 003 | 3-mil     | 3¾" x 6¾"   | 0.20 | \$30.47 |
| 37 940 004 | 3-mil     | 4¾" x 7¾"   | 0.20 | 31.51   |
| 37 940 006 | 3-mil     | 8" x 10"    | 0.40 | 34.98   |
| 37 940 007 | 3-mil     | 8¾" x 11½"  | 0.20 | 37.93   |
| 37 940 008 | 3-mil     | 8¾" x 14½"  | 0.70 | 39.58   |
| 37 940 009 | 3-mil     | 9" x 12"    | 0.50 | 37.58   |
| 37 940 010 | 3-mil     | 9" x 14½"   | 0.60 | 52.89   |
| 37 940 011 | 3-mil     | 11" x 17"   | 1.00 | 55.74   |
| 37 940 012 | 3-mil     | 11½" x 14½" | 0.90 | 57.07   |
| 37 940 013 | 3-mil     | 11½" x 16¾" | 0.70 | 61.09   |
| 37 940 014 | 3-mil     | 16¾" x 20½" | 1.30 | 79.49   |

| CAT.#      | THICKNESS | FITS UP TO  | LBS. | PRICE    |
|------------|-----------|-------------|------|----------|
| 37 941 001 | 4-mil     | 18" x 24"   | 1.90 | \$109.45 |
| 37 941 003 | 4-mil     | 20" x 24"   | 2.10 | 149.75   |
| 37 941 005 | 4-mil     | 24" x 30"   | 3.20 | 190.48   |
| 37 941 009 | 4-mil     | 31½" x 47½" | 6.40 | 366.52   |

All sleeves and envelopes on this page are made of Melinex® – a high-clarity polyester film with high tensile strength and chemical stability to keep stored materials in place. Super-clear material is chemically inert, and will not discolour, cause damage to contents, or adhere to stored materials. Protects documents, photos, prints, and more from dust, dirt, and fingerprints.

## Archival Melinex® Envelopes

Archival-safe, high-clarity polyester envelopes are sealed on three sides

- Short side of each envelope is open; back extends 1/2" for easy access

- Super-clear envelopes are stable, inert, and will not adhere to the surface of stored photos
- 10 envelopes per pack

| CAT.#      | THICKNESS | UP TO     | FITS LBS. | PRICE   |
|------------|-----------|-----------|-----------|---------|
| 37 942 001 | 3-mil     | 4" x 6"   | 0.10      | \$37.41 |
| 37 942 002 | 3-mil     | 5" x 7"   | 0.20      | 38.77   |
| 37 942 003 | 3-mil     | 8½" x 11" | 0.50      | 55.78   |
| 37 942 004 | 3-mil     | 9" x 12"  | 0.70      | 55.18   |
| 37 942 005 | 3-mil     | 11" x 14" | 0.80      | 76.76   |

| CAT.#      | THICKNESS | UP TO     | FITS LBS. | PRICE   |
|------------|-----------|-----------|-----------|---------|
| 37 943 001 | 4-mil     | 5" x 7"   | 0.30      | \$44.93 |
| 37 943 002 | 4-mil     | 6" x 9"   | 0.30      | 48.63   |
| 37 943 003 | 4-mil     | 8" x 10½" | 0.60      | 50.47   |
| 37 943 004 | 4-mil     | 8½" x 11" | 0.70      | 57.32   |
| 37 943 005 | 4-mil     | 11" x 17" | 0.80      | 80.58   |

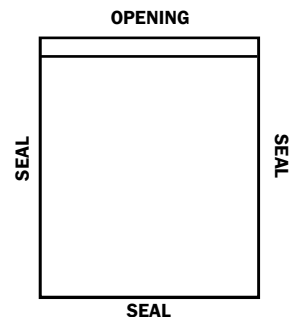

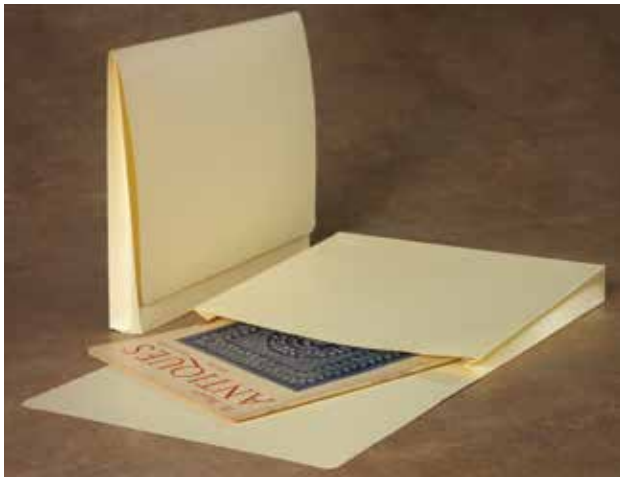

### Expansion Wallets with Flap

Large overhanging flap serves to protect contents

- Pale cream-coloured wallets feature pleats that are pre-scored to expand up to 1½"
- Five wallets per package

**Specifications**

- 10-pt. stock
- Acid-free, lignin-free
- 8.5 +/- pH
- 3% calcium carbonate buffer
- P.A.T. Certified

| CAT.#      | DESCRIPTION | H x W       | LBS. | PRICE   | 10+     |
|------------|-------------|-------------|------|---------|---------|
| 49 362 001 | Letter      | 10¼" x 12¾" | 0.80 | \$49.95 | \$47.45 |
| 49 362 002 | Legal       | 10¼" x 14¾" | 1.00 | 50.34   | 47.83   |



### Hanging File Folders

Hanging file folders include standard metal hanging rods, index tabs, and inserts

- Made of 10-pt. cream-coloured stock
- 25 per package

**Specifications**

- 10-pt. cream stock
- Acid-free, lignin-free
- 8.5 pH
- 3% calcium carbonate buffer
- P.A.T. Certified

| CAT.#      | DESCRIPTION | H x W      | LBS. | PRICE   | 10+     |
|------------|-------------|------------|------|---------|---------|
| 49 230 011 | Letter      | 9½" x 11¾" | 3.50 | \$49.22 | \$46.76 |
| 49 230 014 | Legal       | 9½" x 14¾" | 4.50 | 53.28   | 50.61   |



### Expansion Wallets with Ribbon

Tyvek®-gusseted sides and bottom provide added strength and durability

- Cream-coloured wallets have a ribbon closure

**Specifications**

- 20-pt. cream stock
- Acid-free, lignin-free
- Tyvek® gussets
- 3% calcium carbonate buffer
- P.A.T. Certified

| CAT.#      | DESCRIPTION | H x W x GUSSET   | LBS. | PRICE   | 10+     |
|------------|-------------|------------------|------|---------|---------|
| 49 330 001 | Letter      | 9½" x 11¾" x 3½" | 0.30 | \$26.23 | \$24.92 |
| 49 330 101 | Letter      | 9½" x 11¾" x 5"  | 0.30 | 26.86   | 25.52   |
| 49 330 002 | Legal       | 9½" x 14¾" x 3½" | 0.40 | 26.53   | 25.20   |
| 49 330 102 | Legal       | 9½" x 14¾" x 5"  | 0.40 | 27.07   | 25.72   |



**For Premium-Quality Archival-Safe Labels,**  
see pages 102-103.



### Specifications

- 10-pt. stock
- Acid-free, lignin-free
- 8.5 +/- pH
- 3% calcium carbonate buffer
- P.A.T. Certified



### Full-Cut Reinforced Tab Folders

Shrink-wrapped to preserve archival integrity

- Available in pale cream or dark tan
- Meet Library of Congress specifications
- 100 per box

#### PALE CREAM

| CAT.#      | DESCRIPTION | H x W            | TAB SIZE | LBS. | PRICE   | 10+     |
|------------|-------------|------------------|----------|------|---------|---------|
| 49 228 001 | Letter      | 9 7/8" x 11 3/4" | 1"       | 7.00 | \$74.64 | \$70.91 |
| 49 224 001 | Letter      | 9 7/8" x 11 3/4" | 1/2"     | 7.00 | 74.64   | 70.91   |
| 49 228 002 | Legal       | 9 7/8" x 14 3/4" | 1"       | 7.90 | 94.84   | 90.10   |
| 49 224 002 | Legal       | 9 7/8" x 14 3/4" | 1/2"     | 7.90 | 94.84   | 90.10   |

#### DARK TAN

| CAT.#      | DESCRIPTION | H x W            | TAB SIZE | LBS.  | PRICE   | 10+     |
|------------|-------------|------------------|----------|-------|---------|---------|
| 49 225 001 | Letter      | 9 7/8" x 11 3/4" | 1"       | 4.38  | \$74.65 | \$70.91 |
| 49 225 002 | Legal       | 9 7/8" x 14 3/4" | 1"       | 10.46 | 92.30   | 87.68   |

### Specifications

- 10-pt. stock
- Acid-free, lignin-free
- 8.5 +/- pH
- 3% calcium carbonate buffer
- P.A.T. Certified



### Standard File Folders

Available in full-cut, half-cut, and third-cut tabs with rounded corners

- Shrink-wrapped to preserve archival integrity
- Meet Library of Congress specifications
- 100 per box

| CAT.#      | DESCRIPTION | H x W            | TAB SIZE      | LBS. | PRICE   | 10+     |
|------------|-------------|------------------|---------------|------|---------|---------|
| 49 231 001 | Letter      | 9 7/8" x 11 3/4" | 1/2" Full-Cut | 6.10 | \$63.85 | \$60.60 |
| 49 231 002 | Letter      | 9 7/8" x 11 3/4" | 1" Half-Cut   | 6.45 | 63.85   | 60.60   |
| 49 231 003 | Letter      | 9 7/8" x 11 3/4" | 1" Third-Cut  | 6.45 | 63.85   | 60.60   |
| 49 231 007 | Letter      | 9 7/8" x 11 3/4" | 1" Full-Cut   | 6.45 | 80.52   | 76.49   |
| 49 231 004 | Legal       | 9 7/8" x 14 3/4" | 1/2" Full-Cut | 8.50 | \$80.52 | \$76.49 |
| 49 231 005 | Legal       | 9 7/8" x 14 3/4" | 1" Half-Cut   | 7.70 | 80.52   | 76.49   |
| 49 231 006 | Legal       | 9 7/8" x 14 3/4" | 1" Third-Cut  | 7.80 | 80.52   | 76.49   |
| 49 231 008 | Legal       | 9 7/8" x 14 3/4" | 1" Full-Cut   | 7.80 | 98.68   | 93.74   |

### Specifications

- 10-pt. stock
- Acid-free, lignin-free
- 8.5 +/- pH
- 3% calcium carbonate buffer
- P.A.T. Certified

### Oversized File Folders

Safely protect larger material

- Protect and store oversized prints, documents, and photographs
- 10 per package

| CAT.#      | H x W     | LBS. | PRICE   |
|------------|-----------|------|---------|
| 38 436 001 | 11" x 17" | 1.20 | \$34.95 |
| 38 436 002 | 16" x 20" | 1.40 | 57.45   |



### Specifications

- 20-pt. cream stock
- Acid-free, lignin-free
- 8.5 pH
- 3% calcium carbonate buffer
- P.A.T. Certified



### Heavyweight File Folders

Twice the thickness of regular file folders

- Both letter- and legal-size folders feature non-reinforced, full-cut tabs for easy identification
- Meet Library of Congress specifications
- 25 per package

| CAT.#      | DESCRIPTION | H x W            | LBS. | PRICE   | 10+     |
|------------|-------------|------------------|------|---------|---------|
| 49 312 001 | Letter      | 9 7/8" x 11 3/4" | 3.00 | \$45.66 | \$43.38 |
| 49 312 002 | Legal       | 9 7/8" x 14 3/4" | 4.00 | 62.40   | 59.28   |

### Specifications

- 10-pt. stock
- Acid-free, lignin-free
- 8.5 +/- pH
- 3% calcium carbonate buffer
- P.A.T. Certified



### Pleated File Jackets

Sturdy jackets feature 1" pleat for expansion, 1" extended reinforced tab for labelling

- Meet Library of Congress specifications
- 10 per package

| CAT.#      | DESCRIPTION | H x W         | LBS. | PRICE   | 10+     |
|------------|-------------|---------------|------|---------|---------|
| 49 363 001 | Letter      | 10" x 11 3/4" | 0.60 | \$63.09 | \$59.93 |
| 49 363 002 | Legal       | 10" x 14 3/4" | 0.70 | 68.19   | 64.78   |

### Specifications

- 10- or 20-pt. tan folder stock
- Acid-free, lignin-free
- 8.5 pH
- 3% calcium carbonate buffer



### Map and Print Folders

Oversize folders are ideal for protecting maps and large prints inside flat files or **acid-free** boxes

- Folders are straight cut and flush folded
- 10 folders per pack

#### 10-PT.

| CAT.#             | H x W     | LBS.  | PRICE    | 10+      |
|-------------------|-----------|-------|----------|----------|
| <b>38 346 101</b> | 18" x 24" | 3.30  | \$ 68.83 | \$ 65.39 |
| <b>38 346 102</b> | 20" x 24" | 3.53  | 72.09    | 68.49    |
| <b>38 346 103</b> | 20" x 30" | 4.60  | 87.30    | 82.94    |
| <b>38 346 104</b> | 24" x 36" | 8.00  | 98.56    | 93.63    |
| <b>38 346 105</b> | 30" x 42" | 11.00 | 138.81   | 131.87   |
| <b>38 346 106</b> | 36" x 48" | 14.00 | 161.34   | 153.27   |

#### 20-PT. (HEAVY-WEIGHT)

| CAT.#             | H x W     | LBS.  | PRICE    | 10+      |
|-------------------|-----------|-------|----------|----------|
| <b>38 347 103</b> | 36" x 48" | 12.50 | \$262.11 | \$249.01 |



### Polyester Rolls

**Acid-free** archival grade polyester (Mylar) is chemically inert and will not discolour or cause damage with age

- Polyester is a versatile product that can be used for encapsulation, book protection, interleaving, wrapping, and lining shelves
- Choose from a variety of mil thicknesses and film clarities

#### SafePack

#### LO-LUSTRE 1.5-MIL

| CAT.#             | SIZE       | LBS. | PRICE    | 3+       |
|-------------------|------------|------|----------|----------|
| <b>10 612 001</b> | 12" x 300' | 4.00 | \$ 99.98 | \$ 94.98 |
| <b>10 614 001</b> | 14" x 300' | 4.80 | 111.03   | 105.48   |
| <b>10 616 001</b> | 16" x 300' | 5.40 | 128.27   | 121.86   |
| <b>10 617 001</b> | 24" x 300' | 7.03 | 178.79   | 169.85   |

#### CLEAR 2-MIL

| CAT.#             | SIZE       | LBS. | PRICE    | 3+       |
|-------------------|------------|------|----------|----------|
| <b>10 120 112</b> | 12" x 150' | 4.10 | \$ 60.38 | \$ 57.36 |
| <b>10 120 116</b> | 16" x 150' | 2.80 | 83.88    | 79.68    |
| <b>10 120 120</b> | 20" x 150' | 3.20 | 95.80    | 91.01    |
| <b>10 120 010</b> | 10" x 300' | 3.70 | 91.66    | 87.08    |
| <b>10 120 012</b> | 12" x 300' | 4.20 | 101.11   | 96.05    |
| <b>10 120 014</b> | 14" x 300' | 5.10 | 113.66   | 107.98   |
| <b>10 120 020</b> | 20" x 300' | 6.40 | 143.85   | 136.66   |

#### CLEAR 3- AND 5-MIL\*

| CAT.#             | SIZE      | THICKNESS | LBS. | PRICE    | 3+       |
|-------------------|-----------|-----------|------|----------|----------|
| <b>55 179 003</b> | 40" x 50' | 3-mil     | 6.60 | \$261.82 | \$248.73 |
| <b>55 179 005</b> | 40" x 50' | 5-mil     | 9.00 | 296.33   | 281.51   |

\*Oversized rolls ship in cartons.

#### SUPER CLEAR 1.5-MIL

| CAT.#             | SIZE       | LBS. | PRICE    | 3+       |
|-------------------|------------|------|----------|----------|
| <b>10 115 012</b> | 12" x 300' | 4.00 | \$ 92.61 | \$ 87.98 |
| <b>10 115 014</b> | 14" x 300' | 4.80 | 105.89   | 100.59   |
| <b>10 115 016</b> | 16" x 300' | 5.40 | 112.01   | 106.41   |
| <b>10 115 020</b> | 20" x 300' | 6.20 | 134.37   | 127.65   |

#### SUPER CLEAR 4-MIL

| CAT.#             | SIZE      | LBS. | PRICE    | 3+       |
|-------------------|-----------|------|----------|----------|
| <b>55 178 009</b> | 9" x 50'  | 2.97 | \$ 75.39 | \$ 71.62 |
| <b>55 178 010</b> | 10" x 50' | 3.26 | 78.78    | 74.84    |
| <b>55 178 012</b> | 12" x 50' | 3.48 | 84.46    | 80.24    |
| <b>55 178 014</b> | 14" x 50' | 4.25 | 96.86    | 92.02    |
| <b>55 178 020</b> | 20" x 50' | 5.24 | 128.66   | 122.22   |

### Archival Polyester Encapsulation Sheets

**Acid-free** archival grade super clear 2-mil polyester (Mylar) sheets

- Chemically inert
- Use with Scotch® 415 tape (sold below) to encapsulate documents or photos
- 50 sheets per package.



| CAT.#             | INTERIOR H x W | LBS. | PRICE   | 10+     |
|-------------------|----------------|------|---------|---------|
| <b>10 390 001</b> | 8½" x 11"      | 0.75 | \$26.87 | \$25.53 |
| <b>10 390 002</b> | 10" x 12"      | 1.00 | 28.47   | 27.05   |
| <b>10 390 003</b> | 12" x 14"      | 1.40 | 32.45   | 30.83   |
| <b>10 390 004</b> | 18¾" x 26"     | 4.10 | 77.59   | 73.71   |

### Scotch® Double-Coated Clear 415 Tape

Use for encapsulating or mounting photos

- Double-coated tapes feature high-tack acrylic adhesive and 60-lb. high-density paper liner
- Won't dry out, crack, or yellow with age
- All rolls on 3" core



| CAT.#             | W x L          | LBS. | PRICE   | 5+      |
|-------------------|----------------|------|---------|---------|
| <b>32 415 001</b> | 1/4" x 36 yds. | 0.10 | \$22.07 | \$20.96 |
| <b>32 415 002</b> | 1/2" x 36 yds. | 0.20 | 44.11   | 41.91   |
| <b>32 415 004</b> | 1" x 36 yds.   | 0.50 | 88.27   | 83.85   |

For Bone Folders, see page 82.



**Specifications**

- 10- and 7-pt. buffered folder stock
- Acid-free, lignin-free
- pH-neutral adhesive
- P.A.T. Certified

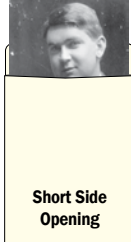

**Storage Envelopes**

Envelopes can be used to protect prints, ephemera, and more

- Envelopes feature pH-neutral adhesive to attach seams and ungummed flaps
- Long side opening envelopes are 10-pt. pale cream stock and 25 per package
- Short side opening envelopes are 7-pt. white stock and 100 per package

| CAT.#      | OPENING    | H x W       | LBS. | PRICE    | 10+      |
|------------|------------|-------------|------|----------|----------|
| 49 235 001 | Long Side  | 9½" x 11¾"  | 2.00 | \$ 45.33 | \$ 43.06 |
| 49 235 002 | Long Side  | 9½" x 14¾"  | 2.50 | 56.10    | 53.30    |
| 49 235 003 | Long Side  | 11½" x 14¾" | 2.80 | 66.87    | 63.53    |
| 49 236 001 | Short Side | 6" x 9"     | 2.70 | 71.66    | 68.07    |
| 49 236 003 | Short Side | 7" x 10"    | 3.70 | 92.94    | 88.29    |
| 49 236 005 | Short Side | 8½" x 11½"  | 4.60 | 102.78   | 97.64    |
| 49 236 006 | Short Side | 9" x 12"    | 5.60 | 128.24   | 121.83   |
| 49 236 007 | Short Side | 10" x 13"   | 6.30 | 114.23   | 108.52   |
| 49 236 008 | Short Side | 11½" x 15½" | 8.40 | 171.99   | 163.39   |

**ITOYA® Archival-Safe PolyEnvelopes**

PVC-free polypropylene envelopes are chemically stable and feature a Velcro® closure

- Resist moisture, staining, and tears
- #49 612 002 has three holes to fit any three-ring binder; #49 612 003 features a clear business card-size pocket
- P.A.T. Certified

(0.15 lb.)

| CAT.#      | DESCRIPTION                   | H x W      | PRICE  | 10+    |
|------------|-------------------------------|------------|--------|--------|
| 49 612 001 | Letter Side-Loading           | 13" x 9½"  | \$3.23 | \$3.07 |
| 49 612 002 | Letter Side-Loading w/ Holes  | 11½" x 9½" | 3.23   | 3.07   |
| 49 612 003 | Letter Side-Loading w/ Pocket | 11½" x 9"  | 3.45   | 3.28   |

*Prices subject to change; please see [www.brodart.ca](http://www.brodart.ca) for up-to-date prices.*



**Four-Flap Enclosures**

Scores prevent appearance of stress points and flap lines on stored contents

- Four-flap design encloses and protects documents, ephemera, and prints during handling and storage
- Five enclosures per package

**Specifications**

- 10-pt. scored folder stock
- Acid-free, lignin-free
- 3% calcium carbonate buffer
- P.A.T. Certified

**Envelope Slings**

Light-cream slings protect fragile or brittle documents

- Sized to fit top-opening envelopes (sold separately)
- 10 slings per package

**Specifications**

- 7-pt. buffered stock
- Acid-free, lignin-free
- 8.5 pH

| AT.#       | WORKING DEPTH | H x W      | LBS. | PRICE   | 10+     |
|------------|---------------|------------|------|---------|---------|
| 38 479 001 | 1/4"          | 8" x 6"    | 0.60 | \$34.80 | \$33.06 |
| 38 479 002 | 1/4"          | 9½" x 6½"  | 0.80 | 34.87   | 33.13   |
| 38 479 005 | 1/4" and 1/2" | 11½" x 9"  | 1.80 | 33.32   | 31.65   |
| 38 479 006 | 1/4" and 1/2" | 15¾" x 9"  | 2.00 | 47.04   | 44.69   |
| 38 479 007 | 1/4" and 1/2" | 13¾" x 10" | 2.50 | 47.08   | 44.73   |
| 38 479 008 | 1/4" and 1/2" | 14¾" x 11" | 3.00 | 47.47   | 45.09   |

| CAT.#      | SLING SIZE | FITS ENVELOPE SIZE | LBS. | PRICE   | 10+     |
|------------|------------|--------------------|------|---------|---------|
| 49 229 003 | 8¾" x 10¾" | 8¾" x 11½"         | 0.40 | \$20.25 | \$19.24 |
| 49 229 005 | 9¾" x 12¾" | 10" x 13"          | 0.50 | 24.81   | 23.57   |



### Large Storage Bags

2-mil polyethylene bags protect prints, ephemera, and other materials against fingerprints, dust, and moisture

- 100 archival-quality bags per package
- P.A.T. Certified

| CAT.#             | SIZE      | LBS. | PRICE    | 5+      |
|-------------------|-----------|------|----------|---------|
| <b>38 559 001</b> | 8" x 10"  | 1.20 | \$ 16.92 | \$16.08 |
| <b>38 559 002</b> | 11" x 14" | 1.20 | 39.15    | 37.19   |
| <b>38 559 003</b> | 14" x 18" | 1.50 | 57.13    | 54.27   |
| <b>38 559 004</b> | 16" x 20" | 2.00 | 73.52    | 69.84   |
| <b>38 559 005</b> | 20" x 24" | 2.50 | 103.67   | 98.49   |



### Slide-Rite Storage Bags

Easy to open and handle while wearing gloves

- 2.7-mil archival-quality bags are equipped with a secure sliding plastic seal to protect valuables
- 50 bags per package

| CAT.#             | SIZE      | LBS. | PRICE   | 10+     |
|-------------------|-----------|------|---------|---------|
| <b>38 589 001</b> | 8" x 7"   | 1.00 | \$43.98 | \$41.78 |
| <b>38 589 003</b> | 14" x 11" | 2.00 | 74.01   | 70.31   |
| <b>38 589 004</b> | 9" x 12"  | 1.80 | 55.85   | 53.06   |
| <b>38 589 005</b> | 16" x 12" | 2.50 | 86.58   | 82.25   |



**Prices subject to change; please see  
www.brodart.ca  
for up-to-date prices.**

### Zip-Lock Storage Bags

Soft 2-mil uncoated archival-quality bags feature a zip-lock seal to protect contents from dust and moisture

- 100 bags per package

| CAT.#             | SIZE     | LBS. | PRICE   | 5+      |
|-------------------|----------|------|---------|---------|
| <b>38 689 005</b> | 2" x 3"  | 0.50 | \$ 7.69 | \$ 7.30 |
| <b>38 689 001</b> | 6" x 4"  | 0.50 | 8.08    | 7.67    |
| <b>38 689 002</b> | 7" x 5"  | 1.00 | 14.66   | 13.93   |
| <b>38 689 003</b> | 8" x 6"  | 1.20 | 17.80   | 16.91   |
| <b>38 689 004</b> | 12" x 9" | 2.10 | 18.73   | 17.79   |



## Art Profolio® PolyZip™ Art & Photo Envelopes

Acid-free, lignin-free, archival-safe 20-mil polypropylene envelopes provide storage for valuable artwork and photography

- Easy-to-use zip closure seals out dust and moisture
- Expanding 1 3/4" gusset provides flexible storage; clear front pocket offers space for indexing, page insertion, or content sample



| CAT.#      | SIZE         | LBS. | PRICE  |
|------------|--------------|------|--------|
| 49 813 001 | 4" x 6"      | 0.06 | \$3.12 |
| 49 813 002 | 5" x 7"      | 0.06 | 3.16   |
| 49 813 003 | 8" x 10"     | 0.12 | 3.96   |
| 49 813 004 | 8 1/2" x 11" | 0.12 | 4.40   |
| 49 813 005 | 9" x 12"     | 0.12 | 4.61   |
| 49 813 006 | 11" x 14"    | 0.19 | 5.44   |
| 49 813 007 | 11" x 17"    | 0.19 | 5.81   |
| 49 813 008 | 13" x 19"    | 0.31 | 7.16   |
| 49 813 009 | 14" x 17"    | 0.31 | 6.40   |



## One-Piece Pamphlet Binders



Built-in single- or double-stitched binder tape for long life

- Binder Covers: Choose 8.0-9.0 pH, **acid-free**, lignin-free 60-pt. archival-quality Barrier Board; also available in polypropylene front with 60-pt. Barrier Board back
- Spine Tape: Grade C Book Cloth permanently attaches and joins covers
- Binder Tape: Grey cambric cloth gummed on one side with **acid-free** adhesive; stitching sewn with cotton thread
- Adhesive: 8.5 pH, water-based, PVA (polyvinyl acetate)
- **Minimum order is 25 binders per size and stitching**

Custom crafted.

*All binders have radius edges;  
specify square edges if desired.*



### ARCHIVAL-QUALITY SINGLE-STITCHED CLEAR POLYPROPYLENE FRONT WITH GREY BOARD BACK BINDERS

| CAT.#      | H x W            | 25+     |
|------------|------------------|---------|
| 52 603 001 | 7" x 5"          | \$ 4.78 |
| 52 603 002 | 9" x 6"          | 5.65    |
| 52 603 003 | 9 1/2" x 6 1/4"  | 6.41    |
| 52 603 004 | 9" x 7"          | 7.00    |
| 52 603 005 | 10" x 7"         | 7.48    |
| 52 603 006 | 10 1/2" x 7 1/4" | 7.87    |
| 52 603 007 | 11" x 8"         | 8.11    |
| 52 603 008 | 11" x 8 1/2"     | 8.33    |
| 52 603 009 | 12" x 9"         | 8.58    |
| 52 603 010 | 12" x 10"        | 8.67    |
| 52 603 011 | 13" x 10"        | 8.99    |
| 52 603 012 | 14" x 11"        | 10.86   |

*Specify width between stitches when ordering.*



**Single-stitched:** Holds up to 3/8" thickness.



**Double-stitched:** Holds from 1/4" - 2" thickness. (Specify width between stitches - 1/4", 1/2", 3/4", 1", 1 1/4", 1 1/2", 1 3/4", or 2")

### ARCHIVAL-QUALITY SINGLE-STITCHED 60-PT. GREY BOARD BINDERS

| CAT.#      | H x W            | 25+    |
|------------|------------------|--------|
| 52 604 001 | 7" x 5"          | \$4.98 |
| 52 604 002 | 9" x 6"          | 5.83   |
| 52 604 003 | 9 1/2" x 6 1/4"  | 6.36   |
| 52 604 004 | 9" x 7"          | 7.06   |
| 52 604 005 | 10" x 7"         | 7.24   |
| 52 604 006 | 10 1/2" x 7 1/4" | 7.28   |
| 52 604 007 | 11" x 8"         | 7.50   |
| 52 604 008 | 11" x 8 1/2"     | 7.71   |
| 52 604 009 | 12" x 9"         | 8.11   |
| 52 604 010 | 12" x 10"        | 8.44   |
| 52 604 011 | 13" x 10"        | 8.90   |
| 52 604 012 | 14" x 11"        | 9.81   |

### ARCHIVAL-QUALITY DOUBLE-STITCHED 60-PT. GREY BOARD BINDERS

| CAT.#      | H x W            | 25+     |
|------------|------------------|---------|
| 52 605 001 | 7" x 5"          | \$ 5.21 |
| 52 605 002 | 9" x 6"          | 6.08    |
| 52 605 003 | 9 1/2" x 6 1/4"  | 6.59    |
| 52 605 004 | 9" x 7"          | 7.31    |
| 52 605 005 | 10" x 7"         | 7.48    |
| 52 605 006 | 10 1/2" x 7 1/4" | 7.53    |
| 52 605 007 | 11" x 8"         | 7.74    |
| 52 605 008 | 11" x 8 1/2"     | 7.96    |
| 52 605 009 | 12" x 9"         | 8.36    |
| 52 605 010 | 12" x 10"        | 8.68    |
| 52 605 011 | 13" x 10"        | 9.13    |
| 52 605 012 | 14" x 11"        | 10.17   |

*Brodart One-Piece Pamphlet Binders are available with built-in 3M™ Security Strips and are designed to work with your 3M™ electromagnetic detection system. Call for pricing and details.*



### Flip-Top Pamphlet File Box

Heavy-duty corrugated board is acrylic-coated to repel moisture and fingerprints

- Easy-open flip-top with hinged lid offers added protection and easy access to contents
- File box ships flat and ready to assemble

#### Specifications

- B-flute grey stone corrugated board
- Acrylic coated
- Acid-free, lignin-free
- 8.0-9.0 pH
- 3% calcium carbonate buffer
- P.A.T. Certified

| CAT.#      | H x W x D       | LBS. | PRICE   | 10+     |
|------------|-----------------|------|---------|---------|
| 49 185 001 | 12" x 10½" x 5" | 0.20 | \$23.35 | \$22.18 |

For Archival Tissue, see page 16.



### Ledger Book Box

Two-piece box holds heavy ledger books up to 5" thick

- Exposed serrated edge to reduce chance of injury
- Shrink-wrapped with polyethylene to preserve archival integrity
- Deep telescoping lid protects contents from dust and dirt
- Boxes are safe for long-term storage and feature metal-reinforced edges for stacking strength and durability

#### Specifications

- 60-pt. grey/white barrier board
- Acid-free, lignin-free
- 8.0-9.0 pH
- 3% calcium carbonate buffer
- P.A.T. Certified

SafePack

| CAT.#      | H x W x D      | LBS. | PRICE   |
|------------|----------------|------|---------|
| 38 398 001 | 5" x 12" x 12" | 2.50 | \$47.93 |

#### Specifications

- 60-pt. grey/white or black barrier board
- Acid-free, lignin-free
- 8.0-9.0 pH
- 3% calcium carbonate buffer
- P.A.T. Certified



### Clamshell Drop Spine Boxes

One-piece clamshell-style storage boxes can hold individual books, digital prints, or artifacts

- Exposed serrated edge to reduce chance of injury
- Shrink-wrapped with polyethylene to preserve archival integrity
- With drop spines, boxes lie flat for convenient access
- Safe for long-term storage
- All boxes feature metal-reinforced edges for stacking strength and durability

SafePack

Prices subject to change; please see [www.brodart.ca](http://www.brodart.ca) for up-to-date prices.

#### BLACK

| CAT.#      | H x W x D         | LBS. | PRICE   | 10+     |
|------------|-------------------|------|---------|---------|
| 38 379 001 | 3" x 12½" x 9"    | 0.84 | \$36.90 | \$35.06 |
| 38 379 002 | 3" x 15½" x 10½"  | 1.00 | 42.74   | 40.60   |
| 38 379 003 | 3¾" x 17¾" x 11½" | 1.37 | 46.78   | 44.44   |

#### GREY/WHITE

| CAT.#      | H x W x D         | LBS. | PRICE   | 10+     |
|------------|-------------------|------|---------|---------|
| 38 298 001 | 1½" x 6½" x 9½"   | 1.50 | \$16.18 | \$15.37 |
| 38 298 002 | 2½" x 6½" x 9½"   | 1.80 | 18.16   | 17.25   |
| 38 298 003 | 3½" x 6½" x 9½"   | 2.00 | 20.14   | 19.13   |
| 38 298 004 | 1½" x 7½" x 10½"  | 1.50 | 19.78   | 18.79   |
| 38 298 005 | 2½" x 7½" x 10½"  | 1.80 | 20.50   | 19.47   |
| 38 298 006 | 3½" x 7½" x 10½"  | 2.00 | 21.21   | 20.15   |
| 38 359 001 | 3" x 12½" x 9"    | 0.60 | 23.39   | 22.22   |
| 38 359 002 | 3" x 15½" x 10½"  | 1.00 | 30.86   | 29.32   |
| 38 359 003 | 3¾" x 17¾" x 11½" | 1.00 | 32.76   | 31.12   |



### Flip-Top Pamphlet Boxes

Metal-reinforced edges for stacking strength and durability

- Exposed serrated edge to reduce chance of injury
- Shrink-wrapped with polyethylene to preserve archival integrity
- Easy-open hinged lid protects pamphlets, catalogues, manuals, and other documents from dust, dirt, and airborne pollution
- Boxes are safe for long-term storage.

#### SafePack

| CAT.#      | H x W x D       | LBS. | PRICE   | 10+     |
|------------|-----------------|------|---------|---------|
| 49 507 001 | 10" x 7" x 4"   | 2.50 | \$18.39 | \$17.47 |
| 49 505 001 | 11½" x 9" x 4½" | 3.00 | 18.99   | 18.04   |

#### Specifications

- 60-pt. grey/white barrier board
- Acid-free, lignin-free
- 8.0-9.0 pH
- 3% calcium carbonate buffer
- P.A.T. Certified



### Curved-Top Corrugated Pamphlet Files

Open-top design offers instant access to pamphlets, magazines, and other items

- Five files per package
- Files ship flat and ready to assemble (1.75 lbs.)

| CAT.#      | H x W x D       | PRICE   | 10+     |
|------------|-----------------|---------|---------|
| 49 547 001 | 11½" x 4" x 9"  | \$48.14 | \$45.74 |
| 49 547 002 | 11" x 3½" x 10" | 51.14   | 48.58   |

#### Specifications

- B-flute grey stone corrugated board
- Acid-free, lignin-free
- 8.0-9.0 pH
- 3% calcium carbonate buffer
- P.A.T. Certified

### Curved-Top Pamphlet Files

Open-top design offers instant access to pamphlets, periodicals, music scores, and other items

- Exposed serrated edge to reduce chance of injury
- Shrink-wrapped with polyethylene to preserve archival integrity
- Metal-reinforced edges for strength and durability

#### SafePack

#### GREY/WHITE

| CAT.#      | H x W x D       | LBS. | PRICE   | 10+     |
|------------|-----------------|------|---------|---------|
| 49 503 001 | 9" x 3" x 6"    | 2.00 | \$17.01 | \$16.16 |
| 49 504 001 | 9" x 3" x 8"    | 3.00 | 17.12   | 16.27   |
| 49 502 001 | 11" x 3½" x 10" | 1.00 | 17.68   | 16.79   |

#### TAN

| CAT.#      | H x W x D       | LBS. | PRICE   | 10+     |
|------------|-----------------|------|---------|---------|
| 49 502 002 | 11" x 3½" x 10" | 1.50 | \$21.56 | \$20.49 |

#### Specifications

- 60-pt. grey/white or tan
- Acid-free, lignin-free
- 8.0-9.0 pH
- 3% calcium carbonate buffer
- P.A.T. Certified



### Pamphlet File with Case

Safe long-term storage for pamphlets and other materials

- Exposed serrated edge to reduce chance of injury
- Shrink-wrapped with polyethylene to preserve archival integrity
- Case provides added protection for both contents and file box
- Both file and case have metal-reinforced edges for extra stacking strength and durability

#### SafePack

| CAT.#      | H x W x D       | LBS. | PRICE   | 10+     |
|------------|-----------------|------|---------|---------|
| 49 460 001 | 11" x 3½" x 10" | 1.15 | \$29.63 | \$28.15 |

#### Specifications

- 60-pt. grey/white barrier board
- Acid-free, lignin-free
- 8.0-9.0 pH
- 3% calcium carbonate buffer
- P.A.T. Certified



### Buffered Tissue

Thin, flexible tissue is **acid-free**, lignin-free, and chlorine-free

- Buffered with approximately 2.8% calcium carbonate
- pH of 9.0-10.0
- 100 sheets per package

| CAT.#      | SIZE      | LBS. | PRICE    |
|------------|-----------|------|----------|
| 38 275 001 | 20" x 30" | 2.29 | \$105.34 |

### Unbuffered Tissue

Soft, ultra-thin **acid-free** tissue is ideal for use with photographs or textiles made with animal fibres

- 100 sheets per package

| CAT.#      | SIZE      | LBS. | PRICE    |
|------------|-----------|------|----------|
| 38 275 002 | 20" x 30" | 2.01 | \$157.97 |



### Acid-Free Tissue

Soft, thin white tissue is perfect for interleaving, wrapping, and cushioning

- Tissue buffered with 3% calcium carbonate and pH of 8.5; helps prevent acid migration and colour transfer
- Both buffered and unbuffered (7.0 pH) tissue protect against scuffing or breakage during storage and handling
- **P.A.T. Certified**
- 100 sheets per package

#### BUFFERED

| CAT.#      | DESCRIPTION       | LBS.  | PRICE    |
|------------|-------------------|-------|----------|
| 38 018 001 | 10" x 15" Sheets  | 0.90  | \$ 65.73 |
| 38 018 002 | 15" x 20" Sheets  | 1.50  | 119.76   |
| 38 018 003 | 30" x 40" Sheets  | 4.40  | 381.16   |
| 39 003 001 | 40" x 1,000' Roll | 10.50 | 764.11   |

#### UNBUFFERED

| CAT.#      | DESCRIPTION      | LBS. | PRICE    |
|------------|------------------|------|----------|
| 38 211 001 | 10" x 15" Sheets | 0.90 | \$ 62.85 |
| 38 211 002 | 15" x 20" Sheets | 1.50 | 99.23    |
| 39 501 001 | 30" x 250' Roll  | 3.60 | 261.04   |
| 39 501 002 | 30" x 500' Roll  | 5.80 | 362.66   |

### (A) 10-Pt.

#### Folder Stock

Light cream folder stock is **acid-free** and lignin-free

- pH of 8.5; 3% calcium carbonate buffer
- Meets Library of Congress Specifications
- **P.A.T. Certified.**
- 25 sheets per package

32"H x 40"W ships from manufacturer.

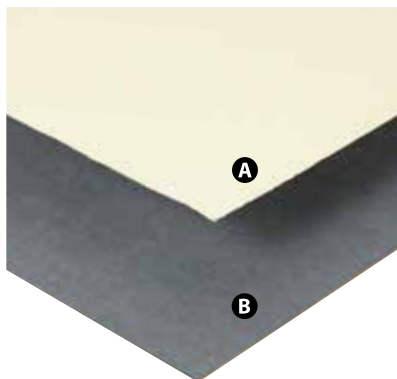

| CAT.#      | H x W     | LBS.  | PRICE    |
|------------|-----------|-------|----------|
| 42 343 001 | 16" x 20" | 4.00  | \$ 85.64 |
| 42 343 002 | 18" x 24" | 7.00  | 90.79    |
| 42 343 003 | 32" x 40" | 12.00 | 161.14   |

### (B) 60-Pt. Barrier Board

Barrier board is used to construct boxes, dividers, mats, pamphlet covers, and more

- Long grain 60-pt. grey/white barrier board is **acid-free** and lignin-free
- pH of 8.0-9.0; 3% calcium carbonate buffer
- **P.A.T. Certified**
- 25 sheets per package

| CAT.#      | H x W     | LBS.  | PRICE    |
|------------|-----------|-------|----------|
| 42 342 001 | 16" x 20" | 36.00 | \$181.59 |



### Glassine Paper

Smooth-textured paper folds easily to create enclosures

- 1-mil, unbuffered, **acid-free**, translucent paper
- pH of 7.0; ideal for interleaving
- 100 sheets per package

Roll ships from manufacturer.

| CAT.#      | H x W             | LBS.  | PRICE    |
|------------|-------------------|-------|----------|
| 42 138 001 | 11" x 14" Sheets  | 4.20  | \$ 30.88 |
| 42 138 003 | 16" x 20" Sheets  | 5.10  | 52.11    |
| 42 138 004 | 48" x 1,000' Roll | 34.00 | 376.12   |





### Exact-Fit Rare Book Boxes

Boxes offer ideal storage for thick pamphlets, softcover books, and fragile or damaged books

- Measure the height and width of your book and select the appropriate size from the table below
- Easy to assemble
- Two boxes (four boards) per package; includes Velcro® attaching buttons

### Specifications

- 20-pt. light tan folder stock
- Acid-free, lignin-free
- 3% calcium carbonate buffer
- P. A. T. Certified

| CAT.#      | H x W     | LBS. | PRICE   | 10+     |
|------------|-----------|------|---------|---------|
| 38 525 001 | 6" x 23"  | 0.30 | \$14.12 | \$13.42 |
| 38 525 002 | 7" x 17"  | 0.30 | 16.69   | 15.85   |
| 38 525 003 | 7" x 25"  | 0.40 | 19.66   | 18.68   |
| 38 525 004 | 8" x 19"  | 0.50 | 18.41   | 17.49   |
| 38 525 005 | 8" x 27"  | 0.70 | 21.89   | 20.80   |
| 38 525 006 | 9" x 21"  | 0.70 | 22.16   | 21.05   |
| 38 525 007 | 9" x 29"  | 0.90 | 23.16   | 22.00   |
| 38 525 008 | 10" x 23" | 1.00 | 22.70   | 21.56   |
| 38 525 009 | 10" x 31" | 1.00 | 23.81   | 22.62   |
| 38 525 010 | 11" x 25" | 1.00 | 23.26   | 22.10   |
| 38 525 011 | 11" x 33" | 1.00 | 24.50   | 23.28   |
| 38 525 012 | 12" x 27" | 1.00 | 24.11   | 22.91   |
| 38 525 013 | 12" x 35" | 1.20 | 25.49   | 24.22   |
| 38 525 014 | 14" x 31" | 1.20 | 38.32   | 36.40   |
| 38 525 015 | 14" x 37" | 1.40 | 43.66   | 41.48   |

**Prices subject to change; please see  
www.brodart.ca  
for up-to-date prices.**

### Tying Tape

Available in 5/16" or 5/8" widths in rolls of 100, 500, or 1,000 yards

- 100% unbleached cotton tape is soft, non-abrasive, free of dye, and reusable
- Tape holds damaged book together until repairs can be made
- Tape can also be used to tie textiles

| CAT.#      | W x L              | LBS. | PRICE    |
|------------|--------------------|------|----------|
| 42 096 001 | 5/16" x 100 yds.   | 1.20 | \$ 45.33 |
| 42 096 002 | 5/16" x 1,000 yds. | 2.50 | 181.45   |
| 42 096 004 | 5/8" x 500 yds.    | 2.30 | 192.29   |
| 42 096 003 | 5/8" x 1,000 yds.  | 4.60 | 326.65   |



### Book Totes

Totes include an insert for partially filled trays

- Grey stone corrugated totes feature an acrylic coating to repel moisture
- Ships flat and ready to assemble

### Specifications

- B-flute grey stone corrugated board
- Acid-free, lignin-free
- Acrylic coated
- 8.0-9.0 pH
- 3% calcium carbonate buffer
- P. A. T. Certified

| CAT.#      | H x W x D     | LBS. | PRICE   |
|------------|---------------|------|---------|
| 49 395 001 | 6" x 17" x 6" | 1.50 | \$17.49 |
| 49 395 002 | 6" x 17" x 7" | 1.80 | 17.75   |
| 49 395 003 | 6" x 17" x 8" | 2.00 | 18.10   |

### Rare Book Identia-Strips

10-pt. acid-free, lignin-free die-cut pale cream strips

- Available with or without tabs
- Tabbed strips feature a cut 1" from top to mark the page
- Non-tabbed strips are ideal for books with brittle pages
- 100 strips per package



| CAT.#      | DESCRIPTION | H x W        | LBS. | PRICE   |
|------------|-------------|--------------|------|---------|
| 38 451 001 | Tabbed      | 5" x 2 1/4"  | 0.40 | \$31.32 |
| 38 451 002 | Tabbed      | 10" x 2 1/4" | 0.80 | 35.74   |
| 38 451 003 | Non-Tabbed  | 10" x 2 1/4" | 0.70 | 12.62   |



### Disposable White Cotton Gloves

**Acid-free** bleached cotton lisle gloves feature reversible design that fits right or left hand

- Form-fitting and lightweight
- 12 pairs per package



| CAT.#      | DESCRIPTION | LBS. | PRICE   |
|------------|-------------|------|---------|
| 55 635 001 | Women's     | 0.10 | \$ 9.42 |
| 55 636 001 | Men's       | 0.10 | 10.19   |



### Sure Grip Cotton Gloves

Non-slip nodules cover the entire surface for a secure grip

- 100% cotton gloves are washable for repeated use
- Not for use with metal artifacts
- 12 pairs per package



| CAT.#      | DESCRIPTION | LBS. | PRICE   |
|------------|-------------|------|---------|
| 55 416 001 | Small       | 1.00 | \$88.94 |
| 55 416 002 | Medium      | 1.00 | 88.94   |
| 55 416 003 | Large       | 1.00 | 88.94   |

### ESD Nylon Gloves

**Acid-free** polygenex nylon gloves dissipate static

- Comfortable to wear all day
- Washable for repeated use
- 12 pairs per package



| CAT.#      | DESCRIPTION | LBS. | PRICE   |
|------------|-------------|------|---------|
| 55 085 001 | Small       | 1.00 | \$44.45 |
| 55 085 002 | Large       | 1.00 | 44.45   |



### Bookkeeper Deacidification Spray

Neutralizes harmful acids; virtually odour-free; dries in minutes

- Will not discolour or damage inks or colours
- Non-toxic, non-flammable; contains no CFCs
- 5.29 oz. refillable pump spray bottle treats over 25 square feet of paper

| CAT.#      | SIZE   | LBS. | PRICE    |
|------------|--|------|----------|
| 38 460 003 | 5.29 oz. Pump Spray                          | 0.50 | \$110.55 |
| 38 460 002 | 900 grams/20 Fluid oz. Refill for Pump Spray | 2.60 | 305.47   |



### pH Testing Pen

Easily determines the acidic or alkaline properties of paper and board

- Purple colour denotes a pH level of 6.5 or higher
- Testing may be less reliable on coated or coloured paper

| CAT.#      | LBS. | PRICE   |
|------------|------|---------|
| 55 077 001 | 0.02 | \$12.76 |

### Mini Digital Humidity and Temperature Metre

Metre can be hung or used freestanding and is small enough to use in museum display cases

- Device has an LCD display that measures 1.4"H x 0.7"W and memory for highest temperature, lowest temperature, and humidity readings
- Records temperature ranges from 14°-140° F with +/- 1.8° accuracy and humidity ranges from 10-99% RH with +/- 5% accuracy
- Includes one LR44 battery

**Note:** Displays temperature in Fahrenheit only.



| CAT.#      | H x W x D       | LBS. | PRICE   |
|------------|-----------------|------|---------|
| 40 407 001 | 1½" x 2" x 3/5" | 0.20 | \$66.07 |



## Micron Pens and Pen Sets

Will not smear, feather, or bleed through on most papers

- Archival-quality Pigma® ink meets ASTM and ACMI non-toxicity standards for use in acid-free environments
- All inks are chemically stable, quick-drying, waterproof, and fade-resistant
- Resists discolouring and will not clog or dry out
- 6-Pack Set with black ink includes pt. sizes 005, 01, 02, 03, 05, and 08
- 6-Pack Set/Assorted Colours includes red, blue, green, brown, purple, and black

| CAT.#      | DESCRIPTION             | PT. SIZE | LBS. | PRICE   | 3+      |
|------------|-------------------------|----------|------|---------|---------|
| 55 075 002 | Single Pen/Black Ink    | 05       | 0.10 | \$ 5.78 | \$ 5.49 |
| 55 075 003 | Single Pen/Black Ink    | 08       | 0.10 | 5.78    | 5.49    |
| 36 569 001 | 6-Pack/Black Ink        | Assorted | 0.30 | 33.92   | 32.23   |
| 36 571 001 | 6-Pack/Assorted Colours | 05       | 0.30 | 33.92   | 32.23   |

**For Scotch® Double-Coated Clear 415 Tape, see page 10.**



## Archival Photo Mounting Corners

Will not damage photos or paper and require no messy glue, mounting adhesive, or tape

- 1/2" polyester corners feature **acid-free**, non-yellowing pressure-sensitive adhesive backing
- 240 corners per package
- **P.A.T. Certified**

| CAT.#      | LBS. | PRICE   |
|------------|------|---------|
| 38 120 001 | 0.10 | \$19.81 |

## Gold, Silver, and White Markers



These permanent ink markers are ideal for videocassettes, decorating, or illustrating

- Work well with paper, vinyl, plastic, photos, and leather
- White marker features a fine-point nib and quick-drying opaque ink

| CAT.#      | COLOUR | POINT      | LBS. | PRICE  |
|------------|--------|------------|------|--------|
| 75 124 001 | Gold   | Medium     | 0.80 | \$7.79 |
| 75 124 002 | Silver | Medium     | 0.72 | 7.79   |
| 75 124 003 | Gold   | Extra Fine | 0.64 | 7.79   |
| 55 066 001 | White  | Fine       | 0.48 | 7.79   |

## Scotch® Double-Sided Scrapbooking Tape

Perfect for mending and repairing pictures, documents, and memorabilia

- Mending tape for photos and documents is totally **acid-free**
- Double-sided tape is independently laboratory-tested and guaranteed safe for use on photos
- Made in the USA
- **P.A.T. Certified**



| CAT.#      | SIZE        | LBS. | PRICE   |
|------------|-------------|------|---------|
| 55 319 002 | 1/2" x 300" | 0.09 | \$13.52 |



## PEC Pad® Photo Wipes

Soft, lint-free, non-abrasive 4" x 4" pads

- Can be safely used to clean sensitive surfaces such as photos, negatives, slides, scanners, CDs, mirrors, lenses, telescopes, and inkjet print heads
- Can be used with PEC-12 photographic emulsion cleaner



| CAT.#      | QUANTITY  | LBS. | PRICE   |
|------------|-----------|------|---------|
| 38 198 002 | 100 Wipes | 0.50 | \$20.95 |



### Three-Ring Binder Pages

Crystal-clear print protection

- 2-mil clear polyester cover
- 10-pt. cream mounting paper pages
- **P.A.T. Certified**, acid-free, and lignin-free
- 50 pages and protectors per package

| CAT.#      | H x W     | LBS. | PRICE    |
|------------|-----------|------|----------|
| 38 214 001 | 11" x 8½" | 2.50 | \$155.09 |



### Topper Sheet Protectors

Protect key documents

- Heavyweight clear polypropylene sheet protectors are pre-punched for three-ring binders
- Top-loading sheets are sealed on three sides with reinforced binding edge
- **P.A.T. Certified**
- 50 per box

| CAT.#      | LBS. | PRICE   | 5+      |
|------------|------|---------|---------|
| 13 162 001 | 1.50 | \$18.94 | \$17.99 |



### SafeCare® Album and Slipcase

110-pt. stock album and slipcase covered in black buckram fabric

- **Acid-free**, pH-neutral
- 2½" spine features three 1½" D rings that accommodate up to 50 pages sized up to 9½" x 12"



| CAT.#      | H x W      | LBS. | PRICE    |
|------------|------------|------|----------|
| 38 680 001 | 12" x 11¾" | 3.00 | \$178.94 |



### Three-Ring Binder Archival Page Protectors

Crystal-clear 4-mil polyester protectors

- Sealed on three sides with one open long side
- Designed to fit any standard three-ring binder album
- **P.A.T. Certified**.
- 25 protectors per package

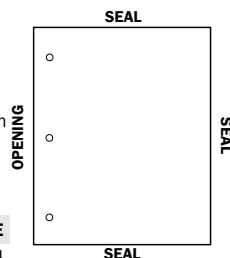

| CAT.#      | H x W     | LBS. | PRICE    |
|------------|-----------|------|----------|
| 38 213 001 | 11¼" x 8" | 0.50 | \$126.94 |



### Oversized Three-Ring Binder Pages

Provide archival-safe storage of prints or documents

- Lightweight 3-mil polyester protectors and 70-lb. white paper inserts
- **Acid-free**, lignin-free
- **P.A.T. Certified**
- 50 protectors and inserts per package

| CAT.#      | SIZE      | LBS. | PRICE    |
|------------|-----------|------|----------|
| 38 369 002 | 10" x 11" | 2.70 | \$104.14 |



### Binder Storage Box

3% calcium carbonate buffer provides safe storage for photos and prints

- Exposed serrated edge to reduce chance of injury
- Shrink-wrapped with polyethylene to preserve archival integrity
- 60-pt. **acid-free**, lignin-free barrier board binder/box; pH of 8.0-9.0
- Hinged lid offers easy access; metal-reinforced edges add stacking strength and durability
- Grey/white box features 2½" spine and 1½" O rings that accept standard three-ring inserts

• **P.A.T. Certified**

**SafePack**

| CAT.#      | H x W x D       | LBS. | PRICE   |
|------------|-----------------|------|---------|
| 38 570 001 | 13" x 12" x 2½" | 1.50 | \$40.41 |



### Three-Ring Binder Box

Archival-safe protection for prints and photos

- Exposed serrated edge to reduce chance of injury
- Shrink-wrapped with polyethylene to preserve archival integrity
- 60-pt. textured black linen binder is **acid-free** and lignin-free; 8.0-9.0 pH; 3% calcium carbonate buffer
- A Velcro® closure secures flap
- 2" built-in D rings accommodate up to 50 pages
- **P.A.T. Certified**

| CAT.#      | H x W x D         | LBS. | PRICE   |
|------------|-------------------|------|---------|
| 38 149 001 | 13¾" x 12¾" x 2¾" | 1.50 | \$81.68 |



**Prices subject to change; please see  
www.brodart.ca  
for up-to-date prices.**

### Three-Ring Binder with Slip Case

Extend the life of photos with archival-safe binder storage

- Exposed serrated edge to reduce chance of injury
- Shrink-wrapped with polyethylene to preserve archival integrity
- Includes a slip case for extra protection from dust and dirt
- Textured black linen 60-pt. board binder and slip case are **acid-free** and lignin-free; 8.0-9.0 pH; 3% calcium carbonate buffer
- Binder features 2" built-in D rings; brass corners offer protection and an elegant appearance
- **P.A.T. Certified**

• **P.A.T. Certified**

**SafePack**

| CAT.#      | H x W x D         | LBS. | PRICE   |
|------------|-------------------|------|---------|
| 38 311 001 | 13¾" x 12¾" x 2¾" | 2.00 | \$81.68 |





**Print File**  
ARCHIVAL STORAGE **Slide Storage Pages**

Strong continuous seams prevent negative hang-up

- PVC-free polypropylene pages
- Provide safe, long-term storage for 20 35mm mounted transparencies
- Extra heavyweight **10-mil** pages
- 25 pages per package

P.A.T. Certified.

| CAT.#      | DESCRIPTION        | H x W                                  | LBS. | PRICE   |
|------------|--------------------|--|------|---------|
| 38 541 002 | Slide Storage Page | 11" x 9 <sup>5</sup> / <sub>16</sub> " | 0.68 | \$28.36 |

*Prices subject to change; please see  
[www.broadart.ca](http://www.broadart.ca)  
for up-to-date prices.*

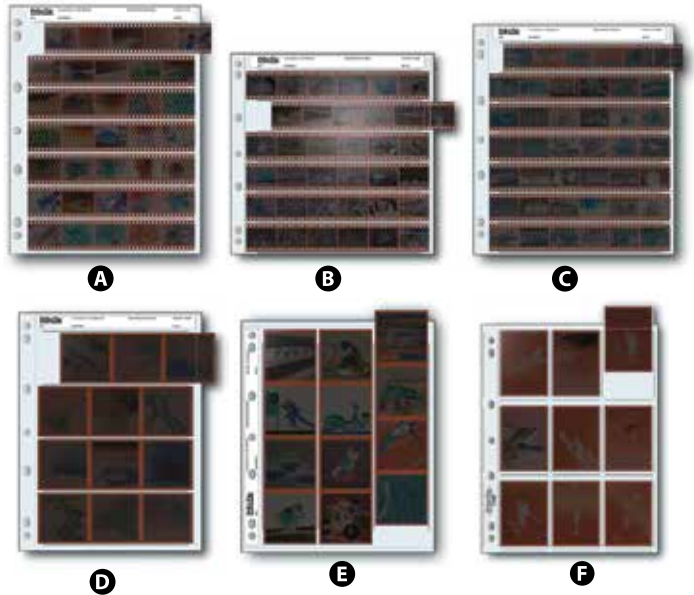

**Print File**  
ARCHIVAL STORAGE **Negative Storage Pages**

Exclusive thin backing and high clarity allow you to make quality contact sheets without removing or handling negatives

- PVC-free polyethylene material is safe for long-term storage
- Strong continuous seams prevent negative hang-up
- Top sheets are **3-mil**; bottom sheets are **1.8-mil**
- 25 pages per package

P.A.T. Certified.

**35MM NEGATIVE PAGES**

| CAT.#      | FRAME CAPACITY           | H x W  | LBS. | PRICE   |
|------------|--------------------------|--|------|---------|
| 38 539 001 | (A) Seven 5-Frame Strips | 11 <sup>1</sup> / <sub>16</sub> " x 8 <sup>5</sup> / <sub>16</sub> " | 0.40 | \$17.46 |
| 38 539 002 | (B) Six 6-Frame Strips   | 9 <sup>3</sup> / <sub>16</sub> " x 10"                               | 0.35 | 17.46   |
| 38 539 003 | (C) Seven 6-Frame Strips | 11 <sup>1</sup> / <sub>16</sub> " x 9 <sup>5</sup> / <sub>16</sub> " | 0.48 | 22.40   |

**120MM NEGATIVE PAGES**

| CAT.#      | FRAME CAPACITY                        | H x W  | LBS. | PRICE   |
|------------|---------------------------------------|--|------|---------|
| 38 538 001 | (D) Four 12- or 8-Frame Strips        | 11 <sup>1</sup> / <sub>16</sub> " x 8 <sup>5</sup> / <sub>16</sub> " | 0.40 | \$17.46 |
| 38 538 002 | (E) Three 15-, 12-, or 9-Frame Strips | 10 <sup>3</sup> / <sub>16</sub> " x 8 <sup>1</sup> / <sub>16</sub> " | 0.38 | 17.46   |
| 38 538 003 | (F) Nine Individual Frames            | 11 <sup>1</sup> / <sub>16</sub> " x 8 <sup>5</sup> / <sub>16</sub> " | 0.60 | 19.59   |



Print Size: 3 1/2" x 5"



Print Size: 4" x 6"



Print Size: 5" x 7"



Print Size: 8" x 10"

**Print File**  
ARCHIVAL STORAGE **Album Pages**

Pages will not crack or tear and are universal to fit multiple binder styles

- Durable **8-mil** polypropylene archival pages
- Ideal for storing photographs and digital prints
- Choose clear pages or black background to enhance photos
- 25 pages per package

P.A.T. Certified.

**BLACK BACKGROUND**

| CAT.#      | PRINT SIZE  | PRINT CAPACITY | LBS. | PRICE   |
|------------|-------------|----------------|------|---------|
| 38 540 001 | 3 1/2" x 5" | 8              | 0.75 | \$26.37 |
| 38 540 002 | 4" x 6"     | 6              | 0.75 | 26.37   |
| 38 540 003 | 5" x 7"     | 4              | 0.75 | 26.37   |
| 38 540 004 | 8" x 10"    | 2              | 0.75 | 26.37   |

**CLEAR**

| CAT.#      | PRINT SIZE  | PRINT CAPACITY | LBS. | PRICE   |
|------------|-------------|----------------|------|---------|
| 38 540 101 | 3 1/2" x 5" | 8              | 0.69 | \$23.60 |
| 38 540 102 | 4" x 6"     | 6              | 0.69 | 23.60   |
| 38 540 103 | 5" x 7"     | 4              | 0.69 | 23.60   |
| 38 540 104 | 8" x 10"    | 2              | 0.69 | 23.60   |



## Negative and Print Envelopes

Paper stock envelopes feature thumb-cut for easy retrieval

- Choose buffered for brittle or mounted prints
- Choose unbuffered for safe, long-term storage of modern photos and negatives
- 100 per package (except 38 105 005, which is 50 per package)

## Specifications

- Acid-free, lignin-free
- pH-neutral adhesive
- P.A.T. Certified

### BUFFERED

| CAT.#      | SIZE                                   | LBS. | PRICE   |
|------------|--|------|---------|
| 38 104 001 | 4 $\frac{3}{8}$ " x 5 $\frac{1}{2}$ "  | 1.20 | \$70.24 |
| 38 104 002 | 5 $\frac{3}{8}$ " x 7 $\frac{3}{8}$ "  | 1.90 | 79.85   |
| 38 104 003 | 8 $\frac{1}{2}$ " x 10 $\frac{1}{2}$ " | 3.70 | 84.24   |

### UNBUFFERED

| CAT.#       | SIZE                                    | LBS. | PRICE    |
|-------------|---|------|----------|
| 38 105 001  | 4 $\frac{7}{8}$ " x 5 $\frac{1}{2}$ "   | 1.50 | \$ 77.57 |
| 38 105 002  | 4 $\frac{3}{8}$ " x 6 $\frac{3}{8}$ "   | 1.60 | 87.33    |
| 38 105 003  | 5 $\frac{3}{8}$ " x 7 $\frac{3}{8}$ "   | 2.00 | 87.24    |
| 38 105 004  | 8 $\frac{1}{2}$ " x 10 $\frac{1}{2}$ "  | 2.60 | 133.56   |
| 38 105 005* | 11 $\frac{1}{2}$ " x 14 $\frac{1}{2}$ " | 2.00 | 151.45   |

\*50 per pkg.



## Four-Flap Negative Enclosures

Enclosures adjust to single fold, 1/16" fold, or 1/8" fold to enclose various sizes of negatives or plates

- 7-pt. white unbuffered stock enclosures are prescored for easy creasing
- Store glass and polyester based items emulsion side down; store metal or paper items emulsion side up
- For added protection, cover with acid-free tissue cut to size
- 25 enclosures per package
- P.A.T. Certified

| CAT.#      | STORAGE PANEL SIZE                     | LBS. | PRICE   |
|------------|--|------|---------|
| 38 776 001 | 4 $\frac{1}{8}$ " x 5 $\frac{1}{8}$ "  | 0.50 | \$49.88 |
| 38 777 001 | 5 $\frac{1}{8}$ " x 7 $\frac{1}{8}$ "  | 0.85 | 56.51   |
| 38 778 001 | 8 $\frac{1}{8}$ " x 10 $\frac{1}{8}$ " | 2.00 | 77.07   |



## Slide Storage Box

Sturdy light cream box includes 20 mini slide boxes to create separate compartments within the storage box itself

- Exposed serrated edge to reduce chance of injury
- Shrink-wrapped with polyethylene to preserve archival integrity
- Storage box is made of acid-free, lignin-free 60-pt. barrier board
- pH of 8.0-9.0, 3% calcium carbonate buffer
- Box features hinged clamshell lid for easy access and metal-reinforced edges for stacking strength and durability
- Mini slide boxes each hold up to twenty 2" x 2" slides, total of 400 slides per box
- P.A.T. Certified

### SafePack

| CAT.#      | H x W x D     | LBS. | PRICE   |
|------------|---------------|------|---------|
| 38 671 011 | 2" x 11" x 6" | 0.60 | \$47.25 |

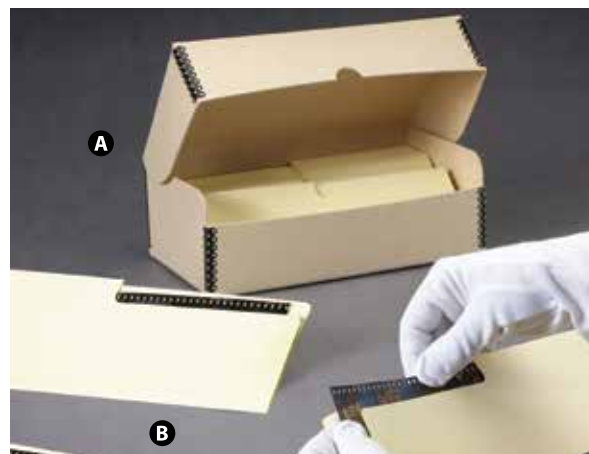

## (A) Negative Strip File Box

Provides safe storage for 35mm negatives

- Exposed serrated edge to reduce chance of injury
- Shrink-wrapped with polyethylene to preserve archival integrity
- One-piece box is made of acid-free, lignin-free 60-pt. tan barrier board
- pH of 8.0-9.0, 3% calcium carbonate buffer
- Box features hinged lid for easy browsing and metal-reinforced edges for stacking strength and durability
- For extra protection, place negatives inside sleeves (sold separately below) before storing
- P.A.T. Certified

### SafePack

| CAT.#      | H x W x D                                   | LBS. | PRICE   |
|------------|---|------|---------|
| 38 531 011 | 3 $\frac{1}{8}$ " x 10 $\frac{1}{2}$ " x 6" | 0.60 | \$25.37 |

## (B) Negative Strip File Sleeves

File sleeves diminish the stress of handling 35mm negatives and protect them from fingerprint damage

- 3 $\frac{1}{8}$ "H sleeves (B) are made of acid-free 10-pt. cream buffered folder stock
- Sized to fit Negative Strip File Box (sold above)
- 50 sleeves per package
- P.A.T. Certified

| CAT.#      | H x W                                  | LBS. | PRICE   |
|------------|--|------|---------|
| 38 532 001 | 3 $\frac{1}{8}$ " x 10 $\frac{1}{2}$ " | 0.30 | \$67.93 |



## ITOYA® Art Profolio

Safe storage for everything from small prints to newspaper spreads

- Albums are **acid-free**, PVC-free, lignin-free
- Crystal-clear polypropylene pages protect materials from dust, dirt, and fingerprints

- Each profolio includes 24 top-loading, permanently bound "pocket" pages pre-loaded with black **acid-free** mounting paper
- **P.A.T. Certified**

### (A) EVOLUTION PROFOLIOS

| CAT.#      | HOLDS PRINT SIZE | LBS. | PRICE   |
|------------|------------------|------|---------|
| 49 181 001 | 4" x 6"          | 0.25 | \$ 9.56 |
| 49 181 006 | 11" x 14"        | 1.10 | 33.27   |
| 49 181 007 | 11" x 17"        | 2.20 | 37.11   |
| 49 181 008 | 13" x 19"        | 1.80 | 56.32   |
| 49 181 010 | 18" x 24"        | 4.70 | 85.80   |

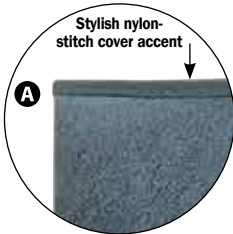

### (B) ARCHIVAL ART PROFOLIOS

| CAT.#      | HOLDS PRINT SIZE | LBS. | PRICE   |
|------------|------------------|------|---------|
| 49 329 005 | 9" x 12"         | 1.00 | \$23.00 |
| 49 329 006 | 11" x 14"        | 1.50 | 33.27   |
| 49 329 007 | 11" x 17"        | 1.80 | 37.11   |
| 49 329 008 | 13" x 19"        | 1.80 | 60.20   |
| 49 329 009 | 14" x 17"        | 2.00 | 60.20   |
| 49 329 010 | 18" x 24"        | 4.70 | 85.64   |

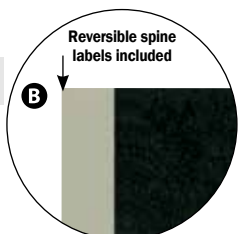

### Photo File Box

Protect your 4" x 6" photos against dust, dirt, and damage inside this long-term storage black linen box

- Exposed serrated edge to reduce chance of injury
- Shrink-wrapped with polyethylene to preserve archival integrity
- Features a shallow lid and metal-reinforced edges for stacking strength and durability
- For extra protection, place photos in envelopes or polyester (Mylar) sleeves before storing

#### Specifications

- 60-pt. black linen board
- **Acid-free**, lignin-free
- 8.0-9.0 pH
- 3% calcium carbonate buffer
- **P.A.T. Certified**

#### SafePack

| CAT.#      | H x W x D     | LBS. | PRICE   |
|------------|---------------|------|---------|
| 49 520 001 | 4" x 6" x 12" | 0.50 | \$32.62 |

For Polyester Envelopes & Sleeves,  
see pages 10-11.



### Divided Photo Storage Box

Long-term storage box features four compartments for organizing your photos

- Exposed serrated edge to reduce chance of injury
- Shrink-wrapped with polyethylene to preserve archival integrity
- Shallow lid and metal-reinforced edges for stacking strength and durability
- Stores up to 1,500 4" x 6" photos loosely in box or up to 740 photos inside photo envelopes (sold separately below)

#### Specifications

- 60-pt. grey/white barrier board
- **Acid-free**, lignin-free
- 8.0-9.0 pH
- 3% calcium carbonate buffer
- **P.A.T. Certified**

#### SafePack

| CAT.#      | DESCRIPTION                   | H x W x D       | LBS. | PRICE   |
|------------|-------------------------------|-----------------|------|---------|
| 38 011 012 | Photo Box                     | 5" x 15½" x 12" | 1.80 | \$46.77 |
| 38 011 003 | Photo Envelopes (100/package) | 4" x 6"         | 0.80 | 77.06   |





## Coroplast™ Portfolios

Lightweight and durable; made of a double-corrugated material that is a copolymer of polypropylene and polyethylene

- pH-neutral, 3-mil, chemically stable portfolios
- Ideal for long-term storage and transportation
- Cut-out front for quick, easy access; built-in handle; latches to keep contents secure

| CAT.#      | H x W     | LBS. | PRICE   |
|------------|-----------|------|---------|
| 49 295 001 | 14" x 18" | 1.00 | \$34.83 |
| 49 295 002 | 17" x 22" | 1.50 | 40.51   |
| 49 295 003 | 23" x 31" | 2.50 | 61.60   |

**Prices subject to change; please see  
www.brodart.ca  
for up-to-date prices.**

## Specifications

- 60-pt. barrier board
- 50-pt Tyvek® laminated barrier board
- Acid-free, lignin-free
- 8.0-9.0 pH
- Grey/white or tan
- 3% calcium carbonate buffer
- P. A.T. Certified



## Drop-Spine Clamshell Boxes

Safe, long-term storage for oversized documents and prints

- Exposed serrated edge to reduce chance of injury
- Shrink-wrapped with polyethylene to preserve archival integrity
- One-piece box with hinged lid allows easy access to contents
- Choose grey/white or tan boxes, both with metal-reinforced edges for stacking strength and durability
- 50-pt. Tyvek®-laminated barrier board boxes provide excellent tear- and water-resistant properties, along with superior flex-fold strength
- Resist mildew and rot, remain pH-neutral, and are fully recyclable

### SafePack

| CAT.#      | DESCRIPTION       | H x W x D        | LBS. | PRICE   | 10+     |
|------------|-------------------|------------------|------|---------|---------|
| 38 314 001 | Grey/White        | 2" x 19½" x 13½" | 2.00 | \$31.06 | \$29.51 |
| 38 314 101 | Tyvek® Grey/White | 2" x 19½" x 13½" | 2.00 | 44.17   | 41.96   |
| 38 314 002 | Grey/White        | 2" x 24½" x 18½" | 2.50 | 42.19   | 40.08   |
| 38 314 004 | Tan               | 2" x 24½" x 18½" | 2.50 | 52.24   | 49.63   |
| 38 314 102 | Tyvek® Grey/White | 2" x 24½" x 18½" | 2.50 | 61.50   | 58.43   |
| 38 314 104 | Tyvek® Tan        | 2" x 24½" x 18½" | 2.50 | 71.65   | 68.06   |



## Drop-Front Digital Print Boxes

Drop-front panel allows easy access to stored digital prints

- Exposed serrated edge to reduce chance of injury
- Shrink-wrapped with polyethylene to preserve archival integrity
- Fully telescoping lid keeps out dust and dirt
- Boxes and lids both feature metal-reinforced edges for stacking strength and durability

## Specifications

- 60-pt. barrier board
- Acid-free, lignin-free
- 8.0-9.0 pH
- Black or tan
- 3% calcium carbonate buffer
- P. A.T. Certified

### SafePack

### BLACK

| CAT.#      | H x W x D         | LBS. | PRICE   | 10+     |
|------------|-------------------|------|---------|---------|
| 38 320 001 | 1½" x 17½" x 11¼" | 1.20 | \$37.40 | \$35.53 |
| 38 320 002 | 1½" x 18½" x 14½" | 1.50 | 60.83   | 57.79   |
| 38 320 003 | 1½" x 19½" x 13½" | 1.50 | 60.24   | 57.23   |
| 38 320 004 | 1½" x 20½" x 16½" | 1.60 | 58.24   | 55.33   |
| 38 320 005 | 1½" x 24½" x 20½" | 2.30 | 74.03   | 70.33   |
| 38 320 006 | 3" x 10½" x 8½"   | 0.80 | 30.78   | 29.24   |
| 38 320 007 | 3" x 19½" x 13½"  | 1.60 | 75.74   | 71.95   |

### TAN

| CAT.#      | H x W x D         | LBS. | PRICE   | 10+     |
|------------|-------------------|------|---------|---------|
| 38 321 001 | 1½" x 17½" x 11¼" | 1.20 | \$32.24 | \$30.62 |
| 38 321 002 | 1½" x 18½" x 14½" | 1.50 | 50.15   | 47.65   |
| 38 321 003 | 1½" x 19½" x 13½" | 1.50 | 49.76   | 47.27   |
| 38 321 004 | 1½" x 20½" x 16½" | 1.60 | 49.23   | 46.77   |
| 38 321 005 | 1½" x 24½" x 20½" | 2.30 | 61.38   | 58.31   |
| 38 321 006 | 3" x 10½" x 8½"   | 0.80 | 27.33   | 25.96   |
| 38 321 007 | 3" x 19½" x 13½"  | 1.60 | 61.63   | 58.55   |

## Specifications

- B-flute grey stone corrugated board
- Acid-free, lignin-free
- 8.0-9.0 pH
- Acrylic-coated
- 3% calcium carbonate buffer
- P. A.T. Certified



## Drop-Front Gallery Boxes

Acrylic-coated to repel moisture

- Two-piece boxes feature drop-front design for easy access and a deep telescoping lid
- All boxes ship flat and ready to assemble

| CAT.#      | H x W x D        | LBS. | PRICE   | 10+     |
|------------|------------------|------|---------|---------|
| 49 528 001 | 3" x 10½" x 15½" | 0.88 | \$29.84 | \$28.35 |
| 49 528 002 | 3" x 20½" x 16½" | 1.40 | 35.21   | 33.45   |
| 49 528 003 | 3" x 24½" x 20½" | 2.80 | 51.23   | 48.67   |
| 49 528 004 | 3" x 31½" x 24½" | 3.00 | 66.25   | 62.94   |



### Two-Piece Photo Storage Box

Features a shallow lid and metal-reinforced edges for stacking strength and durability

- Exposed serrated edge to reduce chance of injury
- Shrink-wrapped with polyethylene to preserve archival integrity
- Extend the life of your photos by storing them in this long-term archival-safe black linen box
- For extra protection, place photos in envelopes or polyester (Mylar) sleeves before storing

#### Specifications

- 60-pt. black linen board
- Acid-free, lignin-free
- 8.0-9.0 pH
- 3% calcium carbonate buffer
- P.A.T. Certified

#### SafePack

| CAT.#      | H x W x D      | LBS. | PRICE   |
|------------|----------------|------|---------|
| 49 509 001 | 5½" x 8" x 11" | 1.80 | \$40.39 |



### One-Piece Photo Storage Boxes

Safe for long-term storage, these boxes feature a hinged lid with flip-top design for easy access

- Exposed serrated edge to reduce chance of injury
- Shrink-wrapped with polyethylene to preserve archival integrity
- Metal-reinforced edges for stacking strength and durability
- For extra protection, place photos in envelopes or polyester (Mylar) sleeves before storing

#### Specifications

- 60-pt. grey/white barrier board
- Acid-free, lignin-free
- 8.0-9.0 pH
- 3% calcium carbonate buffer
- P.A.T. Certified

#### SafePack

| CAT.#      | H x W x D       | LBS. | PRICE   |
|------------|-----------------|------|---------|
| 38 372 001 | 5" x 6" x 2½"   | 0.40 | \$19.67 |
| 38 372 002 | 5¾" x 7¾" x 4½" | 0.40 | 30.65   |

### Quake Hold! Museum Wax and Gel

Safeguard collections against earthquakes, routine dusting, or patron accident

- Non-acidic, non-toxic, and reversible
- Museum Wax is soft and sticky to allow maximum flexibility
- Museum Gel is crystal-clear and suitable for glass and crystal

**Note:** Use on non-porous objects only. Gel contains silicone that may stain porous materials.



| CAT.#      | DESCRIPTION | SIZE   | LBS. | PRICE   |
|------------|-------------|--------|------|---------|
| 38 021 001 | Museum Wax  | 13 oz. | 0.80 | \$67.62 |
| 38 128 001 | Museum Gel  | 4 oz.  | 0.10 | 45.33   |

### Wishab Sponge

Rubs easily over soiled area and forms crumbs that can be brushed off or vacuumed

- Latex sponge is an excellent tool for removing dust and soot from paintings and murals
- Vulcanized sponge is pH-neutral and leaves no residue



| CAT.#      | H x W x D       | LBS. | PRICE   |
|------------|-----------------|------|---------|
| 55 542 001 | 1¾" x 3¾" x 2¾" | 0.15 | \$37.28 |

#### Specifications

- B-flute grey stone corrugated board
- Acid-free, lignin-free
- 8.0-9.0 pH
- 3% calcium carbonate buffer
- P.A.T. Certified



### Protective Frame Corners

**Acid-free** corners fit frames from 1" - 2" thick

- Constructed of heavy-duty corrugated board
- Sturdy corners protect frames from nicks and scratches during storage or transport
- 48 corners per package

Assembled.

| CAT.#      | LBS. | PRICE   |
|------------|------|---------|
| 38 718 001 | 1.70 | \$72.77 |

**Prices subject to change; please see [www.brodart.ca](http://www.brodart.ca) for up-to-date prices.**

### Dexter Mat Cutter

Perfect for scoring cardboard or illustration board

- Allows you to cut mats of any thickness with a straight cut or a professional beveled edge
- Features a chrome-plated metal body that fits comfortably in the hand and a plastic knob that allows blade adjustment for any angle or depth
- Instructions included



| CAT.#      | DESCRIPTION                 | LBS. | PRICE    |
|------------|-----------------------------|------|----------|
| 42 305 001 | Cutter                      | 0.80 | \$112.84 |
| 42 305 101 | Replacement Blades (5-pack) | 0.10 | 13.86    |

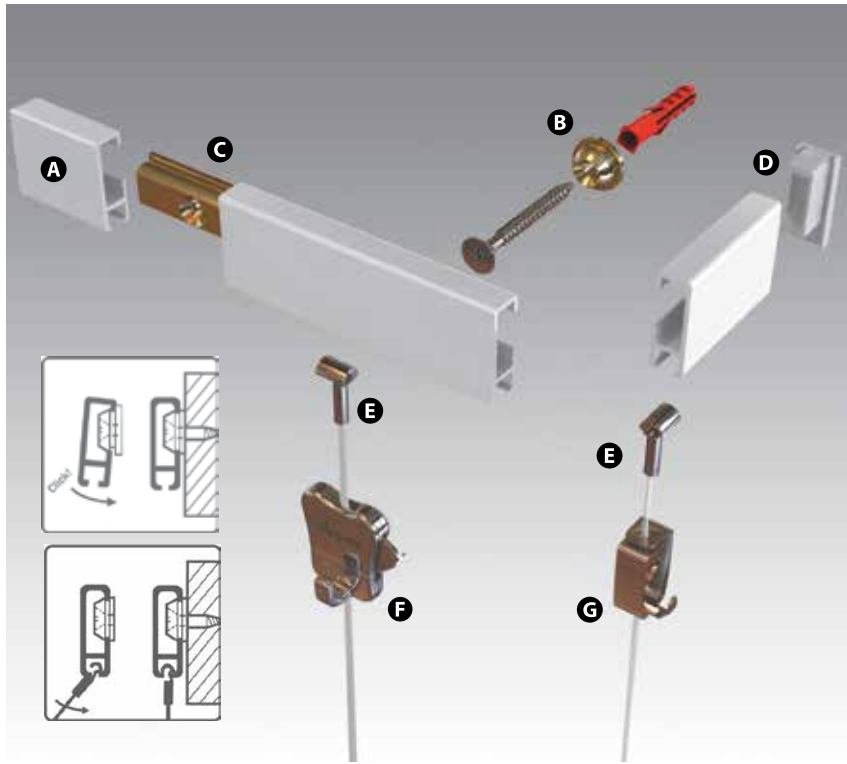

## Hang It Up Systems

Offers complete flexibility to reshuffle wall arrangements without touching or defacing the wall

- The most effective system devised for hanging pictures or exhibits
- With the inconspicuous track installed, hangings can be arranged as needed
- Aluminum hanging system is thick-walled and super strong; can be easily upgraded to incorporate a lighting system (call for details)



### (A) CLIPRAIL 2 TRACK

- Strong aluminum rail can easily be cut to fit shorter spaces or joined to create a larger hanging area
- Track snaps on to brass clip as shown in insets above

| CAT.#   | LENGTH     | LBS. | PRICE   |
|---------|------------|------|---------|
| 38 870* | 78" (6.5') | 1.05 | \$73.53 |

\*Specify colour below.



### (D) END-CAP

- Snaps on easily for neat termination of exposed cliprail ends

| CAT.#   | LBS. | PRICE  |
|---------|------|--------|
| 38 876* | 0.01 | \$4.67 |

\*Specify colour below.



### (B) MOUNTING HARDWARE

- Use to mount track to wall at approximately 12" intervals
- Order one clip, screw, and plug for every 12" of rail purchased

| CAT.#      | DESCRIPTION | LBS. | PRICE  |
|------------|-------------|------|--------|
| 38 872 001 | Brass Clip  | 0.01 | \$1.69 |
| 38 873 001 | Screw       | 0.01 | 0.27   |
| 38 874 001 | Plug        | 0.01 | 0.27   |



### (C) TRACK (STRAIGHT) CONNECTOR

- Connects two pieces of cliprail track when creating a continuous hanging area

| CAT.#      | DESCRIPTION     | LBS. | PRICE  |
|------------|-----------------|------|--------|
| 38 875 001 | Brass Connector | 0.02 | \$4.72 |



Perlon® Steel

### (E) HANGERS

- Choose clear Perlon® cord or stainless steel cable with cobra heads
- Both click easily into rail at any point as shown in insets above, then slide along to the desired position

| CAT.#   | LENGTH      | LBS. | PERLON® | STEEL   |
|---------|-------------|------|---------|---------|
|         |             |      | PRICE   | PRICE   |
| 38 878* | 39" (3.25') | 0.04 | \$11.56 | \$22.52 |
| 38 879* | 59" (4.9')  | 0.04 | 12.73   | 24.47   |
| 38 880* | 78" (6.5')  | 0.04 | 14.13   | 26.27   |

\*Specify material: Perlon®-001 or Steel-002.



### (F & G) ADJUSTABLE HOOKS

- Choose from two hook types, depending on weight and level of security required
- Zipper Hook (F) is a heavy-duty self-locking hook; when used with Perlon® cord, holds up to 22 lbs.; with steel cable, holds up to 33 lbs.
- SmartSpring Hook (G) adjusts easily with pinch action; for use with Perlon® cord only; holds up to 9 lbs.

| CAT.#      | DESCRIPTION          | LBS. | PRICE   |
|------------|----------------------|------|---------|
| 38 883 001 | (F) Zipper Hook      | 0.04 | \$12.60 |
| 38 884 001 | (G) SmartSpring Hook | 0.01 | 6.79    |



## Corrugated Textile Storage Boxes

Sturdy board boxes provide safe, long-term storage for valuable fabrics, textiles, or artifacts

- Boxes offer protection from dust and dirt and feature a shallow lid for easy access
  - Choose uncoated or acrylic-coated to repel moisture
  - For added protection, fill and wrap clothing and fabrics in tissue before storing
- Ships flat and ready to assemble.

### ACRYLIC COATED

| CAT.#      | H x W x D      | LBS. | PRICE   |
|------------|----------------|------|---------|
| 49 371 001 | 6" x 18" x 30" | 3.00 | \$57.20 |
| 49 371 002 | 6" x 18" x 40" | 3.50 | 59.42   |

### UNCOATED

| CAT.#      | H x W x D      | LBS. | PRICE   |
|------------|----------------|------|---------|
| 49 371 101 | 6" x 18" x 30" | 3.00 | \$54.64 |
| 49 371 102 | 6" x 18" x 40" | 3.50 | 57.20   |

### Specifications

- B-flute grey stone corrugated board
- Acid-free, lignin-free
- 8.0-9.0 pH
- 3% calcium carbonate buffer
- P.A.T. Certified



## Flag Storage Box

Heavy-duty triangular-shaped corrugated board box has self-locking lid to keep flag secure and free from deterioration

- Acrylic-coated to protect flag from damage due to moisture

Ships flat and ready to assemble.

| CAT.#      | H x W x D        | LBS. | PRICE   |
|------------|------------------|------|---------|
| 49 539 001 | 3" x 22½" x 15¾" | 0.64 | \$28.93 |

## Cloth Labelling Tape

White cotton twill tape is ideal for labelling fabrics and textiles for easy identification

- Tape can also be used to wrap or tie textiles
- When labelling, use with permanent acid-free washable Pigma Pens (sold on page 19)
- It is recommended that you use a very fine needle and polyester thread when sewing tape to garments or other textiles



| CAT.#      | SIZE          | LBS. | PRICE   |
|------------|---------------|------|---------|
| 42 095 001 | 1"H x 72 yds. | 1.00 | \$75.20 |

## Textile Storage Boxes

Keep costumes, wedding gowns, and other treasured textiles safe from dust and dirt

- Exposed serrated edge to reduce chance of injury
- Shrink-wrapped with polyethylene to preserve archival integrity
- Designed for long-term storage, these two-piece boxes feature a deep telescoping lid
- Boxes and lids have metal-reinforced edges for stacking strength and durability
- For extra protection, fill and wrap clothing and fabrics in tissue before storing

### SafePack

| CAT.#      | H x W x D          | LBS. | PRICE   |
|------------|--------------------|------|---------|
| 38 371 001 | 6" x 18" x 30"     | 3.50 | \$84.83 |
| 49 184 001 | 10¾" x 18¾" x 30½" | 4.00 | 88.98   |



### Specifications

- 60-pt. grey/white barrier board
- Acid-free, lignin-free
- 8.0-9.0 pH
- 3% calcium carbonate buffer
- P.A.T. Certified



## Hat Storage Box

Two-piece box allows safe long-term storage and features a shallow lid for easy access

- Exposed serrated edge to reduce chance of injury
- Shrink-wrapped with polyethylene to preserve archival integrity
- Choose matching grey lid or transparent 30-gauge polypropylene lid for easy content identification
- Both lid and box have metal-reinforced edges for durability and extra stacking strength (12"H x 13½"W x 13¾"D). **SafePack**

| CAT.#      | DESCRIPTION              | LBS. | PRICE   |
|------------|--------------------------|------|---------|
| 32 377 001 | Box with Grey Lid        | 2.16 | \$65.55 |
| 32 377 002 | Box with Transparent Lid | 2.16 | 91.31   |

### Specifications

- 60-pt. grey/white barrier board
- Acid-free, lignin-free
- 8.0-9.0 pH
- 3% calcium carbonate buffer
- P.A.T. Certified

## Shoe Box

Corrugated board box provides safe, long-term storage and features an acrylic coating that protects contents from damage due to moisture

- This box is also great for artifact storage
  - The unique locking 30-pt. polypropylene shallow lid is clear for easy content identification and features metal-reinforced edges for extra stacking strength
- Ships flat and ready to assemble.



### Specifications

- B-flute grey stone corrugated board
- Acid-free, lignin-free
- 8.0-9.0 pH
- 3% calcium carbonate buffer
- P.A.T. Certified

| CAT.#      | H x W x D      | LBS. | PRICE   |
|------------|----------------|------|---------|
| 49 176 001 | 5½" x 13" x 8" | 0.80 | \$24.83 |

## Artifact Carton and Trays

Sturdy, heavy-duty carton

- Individual compartment trays hold small to medium-sized objects
- Metal edges for durability and stacking strength
- Carton ships flat and ready to assemble

### Specifications

- Buffered corrugated board
- Acid-free, lignin-free
- 8.0-9.0 pH
- 3% calcium carbonate buffer
- P.A.T. Certified

| CAT.#      | DESCRIPTION             | COMPARTMENT<br>H x W x D | LBS. | PRICE   |
|------------|-------------------------|--------------------------|------|---------|
| 49 541 001 | Storage Carton with Lid | 10" x 12" x 15"          | 1.30 | \$39.62 |
| 49 542 001 | 4-Compartment Tray      | 5" x 5 3/4" x 7 1/4"     | 0.90 | 50.81   |
| 49 542 002 | 6-Compartment Tray      | 2 1/2" x 5 3/4" x 4 3/4" | 0.70 | 50.81   |
| 49 542 003 | 15-Compartment Tray     | 2 1/2" x 3 3/4" x 2 3/4" | 0.80 | 52.03   |



## Clear Artifact Storage Boxes

Translucent boxes allow a clear view of stored contents, while metal-reinforced edges add stacking strength and durability

- Exposed serrated edge to reduce chance of injury
- Shrink-wrapped with polyethylene to preserve archival integrity
- Two-piece boxes feature deep telescoping lids to offer protection from dust, dirt, and damage
- Tops and bottoms may also be used separately as storage trays in flat file drawers or cabinets

### Specifications

- 30-gauge polypropylene
- Acid-free
- P.A.T. Certified

#### SafePack

| CAT.#      | H x W x D                | LBS. | PRICE   | 5+      |
|------------|--------------------------|------|---------|---------|
| 45 525 101 | 1 3/4" x 2 3/4" x 2 1/2" | 0.10 | \$18.68 | \$17.75 |
| 45 525 102 | 1 3/4" x 3 3/4" x 4"     | 0.10 | 19.55   | 18.57   |
| 45 525 103 | 1 1/2" x 4 3/4" x 6 1/2" | 0.13 | 19.73   | 18.74   |
| 45 525 104 | 1 1/2" x 5 3/4" x 7 1/2" | 0.13 | 20.27   | 19.26   |



## Artifact Storage Boxes

Tops and bottoms may also be used separately as storage trays in flat file drawers or cabinets

- Sturdy two-piece boxes with deep telescoping lids offer safe long-term storage for jewelry, buttons, other small artifacts, or printed materials
- Metal-reinforced edges add durability and stacking strength for increased storage capacity

### Specifications

- 60-pt. tan barrier board
- Acid-free, lignin-free
- 8.0-9.0 pH
- 3% calcium carbonate buffer
- P.A.T. Certified

#### SafePack

| CAT.#      | H x W x D                | LBS. | PRICE   | 5+      |
|------------|--------------------------|------|---------|---------|
| 49 525 001 | 1 3/4" x 2 3/4" x 2 1/2" | 0.10 | \$11.73 | \$11.14 |
| 49 525 002 | 1 3/4" x 3 3/4" x 4"     | 0.10 | 12.25   | 11.64   |
| 49 525 003 | 1 1/2" x 4 3/4" x 6 1/2" | 0.13 | 12.75   | 12.11   |
| 49 525 004 | 1 1/2" x 5 3/4" x 7 1/2" | 0.13 | 12.89   | 12.24   |



### Artifact ID Tags

**Acid-free**, lignin-free ID tags have a pH of 8.5

- Can be used to safely label all archival materials
- Made of tan buffered folder stock, tags include a 12" string (6" after folding for tag loop) for attaching to artifacts
- 100 tags per package



| CAT.#      | H x W           | LBS. | PRICE   |
|------------|-----------------|------|---------|
| 49 575 001 | 3/4" x 3/4"     | 1.00 | \$30.90 |
| 49 575 002 | 1 1/2" x 3 3/4" | 1.00 | 35.17   |

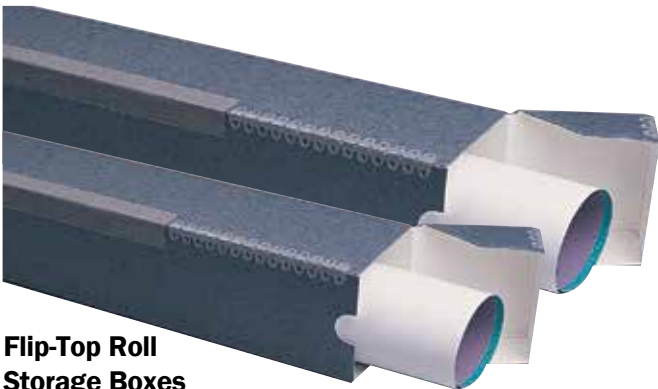

### Flip-Top Roll Storage Boxes

Boxes feature square construction with metal-reinforced and taped edges

- Exposed serrated edge to reduce chance of injury
- Shrink-wrapped with polyethylene to preserve archival integrity
- Durability and stacking strength
- Flip-top lids allow easy access to rolled contents

#### Specifications

- 60-pt. grey/white barrier board
- **Acid-free**, lignin-free
- 8.0-9.0 pH
- 3% calcium carbonate buffer
- **P. A.T. Certified**

#### SafePack

| CAT.#      | SIZE         | LBS. | PRICE   | 5+      |
|------------|--------------|------|---------|---------|
| 38 364 001 | 4" sq. x 30" | 0.90 | \$52.95 | \$50.30 |
| 38 364 002 | 5" sq. x 37" | 1.00 | 55.78   | 52.99   |

### Polypropylene Foam Roll

Ideal for lining steel shelving or exhibit cases

- Soft, non-abrasive, waterproof 1/4"-thick foam
- Can also be used to wrap around fragile items prior to storing or transporting



| CAT.#      | W x L      | LBS. | PRICE    |
|------------|------------|------|----------|
| 38 639 001 | 12" x 125' | 4.00 | \$130.25 |



### SafeCare® Storage Tubes

Offers archival-safe storage for rolled maps, blueprints, drawings, and posters

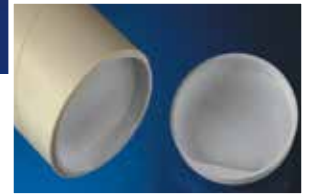

- **Acid-free**, lignin-free buffered board tubes are 3" and 6" in diameter with 3/16"-thick walls
  - Rolls also feature a pH of 8.5 and layers that are bonded with pH-neutral PVA adhesive for safe long-term storage of textiles, carpets, tapestries, quilts, and more
  - Polypropylene caps sold separately below
- Ships from manufacturer.

| CAT.#       | TUBES PER PACK                    | INSIDE DIAMETER x L | LBS.   | PRICE    |
|-------------|-----------------------------------|---------------------|--------|----------|
| 49 815 001  | 10                                | 3" x 2'             | 15.00  | \$217.59 |
| 49 815 002  | 10                                | 3" x 3'             | 19.00  | 347.47   |
| 49 815 003  | 10                                | 3" x 4'             | 31.00  | 435.17   |
| 49 815 004* | 10                                | 3" x 6'             | 38.00  | 653.87   |
| 49 815 005* | 10                                | 3" x 8'             | 50.00  | 871.46   |
| 49 815 006* | 10                                | 3" x 10'            | 82.00  | 1,087.93 |
| 49 815 007* | 10                                | 3" x 12'            | 100.00 | 1,306.63 |
| 49 816 001  | 2                                 | 6" x 2'             | 9.60   | 122.11   |
| 49 816 002  | 2                                 | 6" x 3'             | 11.60  | 195.38   |
| 49 816 003  | 2                                 | 6" x 4'             | 14.40  | 252.00   |
| 49 816 004* | 2                                 | 6" x 6'             | 21.20  | 384.11   |
| 49 816 005* | 2                                 | 6" x 8'             | 30.40  | 506.22   |
| 49 816 006* | 2                                 | 6" x 10'            | 42.40  | 585.04   |
| 49 816 007* | 2                                 | 6" x 12'            | 45.20  | 672.74   |
| 49 817 001  | 20 pk. Caps for 3" Diameter Tubes |                     | 1.00   | 51.14    |
| 49 817 002  | 2 pk. Caps for 6" Diameter Tubes  |                     | 0.20   | 22.67    |

\*Ships via truck.



### Roll Storage Boxes

Versatile boxes open two ways – lengthwise and on the end – providing convenient access to delicate materials

- Heavy-duty pyramidal construction provides stacking strength
- Acrylic-coated board repels moisture
- Boxes ship flat and ready to assemble

#### Specifications

- B-flute grey stone corrugated board
- **Acid-free**, lignin-free
- 8.0-9.0 pH
- 3% calcium carbonate buffer
- **P. A.T. Certified**

#### ACRYLIC COATED

| CAT.#      | SIZE     | LBS. | PRICE   | 10+     |
|------------|----------|------|---------|---------|
| 49 549 001 | 5" x 24" | 1.00 | \$21.13 | \$20.08 |
| 49 549 002 | 6" x 38" | 2.00 | 24.76   | 23.52   |
| 49 549 003 | 6" x 49" | 2.50 | 31.22   | 29.66   |

#### UNCOATED

| CAT.#      | SIZE     | LBS. | PRICE   | 10+     |
|------------|----------|------|---------|---------|
| 49 549 101 | 5" x 24" | 1.00 | \$18.87 | \$17.93 |
| 49 549 102 | 6" x 38" | 2.00 | 21.88   | 20.78   |
| 49 549 103 | 6" x 49" | 2.50 | 30.10   | 28.59   |



## Sheet Music Folders

Protect and separate individual sheet music during storage

- 10-pt. **acid-free**, lignin-free folders
- For long-term storage, these Sheet Music Folders fit into the Sheet Music Boxes (sold below)
- 10 folders per package

**P.A.T. Certified.**

| CAT.#             | H x W                                  | LBS. | PRICE          | 10+            |
|-------------------|--|------|----------------|----------------|
| <b>38 501 001</b> | 12 $\frac{1}{4}$ " x 9 $\frac{1}{2}$ " | 0.60 | <b>\$18.10</b> | <b>\$17.20</b> |
| <b>38 501 002</b> | 15" x 12"                              | 0.60 | <b>23.02</b>   | <b>21.87</b>   |

**Prices subject to change; please see  
www.brodart.ca  
for up-to-date prices.**



## Postcard Box

Two-piece long-term storage box keeps postcards and other valued collections safe from dust, dirt, and damage

- Exposed serrated edge to reduce chance of injury
- Shrink-wrapped with polyethylene to preserve archival integrity
- Shallow lid allows easy access
- Metal-reinforced edges add durability and extra stacking strength for increased storage capability (0.90 lbs.) **SafePack**

### Specifications

- 60-pt. grey/white barrier board
- **Acid-free**, lignin-free
- 8.0-9.0 pH
- 3% calcium carbonate buffer
- **P. A. T. Certified**

| CAT.#             | H x W x D                                   | PRICE          | 10+            |
|-------------------|---|----------------|----------------|
| <b>49 535 002</b> | 4 $\frac{1}{2}$ " x 12" x 6 $\frac{1}{2}$ " | <b>\$21.23</b> | <b>\$20.17</b> |



## Sheet Music Boxes

Boxes feature a drop-front design for easy access

- Exposed serrated edge to reduce chance of injury
- Shrink-wrapped with polyethylene to preserve archival integrity
- Deep telescoping lid guards stored sheet music against dust, dirt, and damage
- Metal-reinforced edges provide stacking strength and durability

**SafePack**

| CAT.#             | H x W x D                                    | LBS. | PRICE          | 10+            |
|-------------------|--|------|----------------|----------------|
| <b>49 390 001</b> | 3" x 10 $\frac{1}{2}$ " x 13 $\frac{1}{2}$ " | 0.50 | <b>\$19.01</b> | <b>\$18.06</b> |
| <b>49 391 001</b> | 3" x 13" x 16"                               | 0.60 | <b>20.36</b>   | <b>19.34</b>   |

### Specifications

- 60-pt. grey/white barrier board
- **Acid-free**, lignin-free
- 8.0-9.0 pH
- 3% calcium carbonate buffer
- **P. A. T. Certified**



## Hinged-Lid Storage Boxes

Corrugated one-piece hinged-lid boxes are perfect for safe long-term storage of metal, wood, plastic, and ceramic artifacts

- Choose acrylic-coated to repel moisture or uncoated
- For extra cushioning and protection, line boxes with tissue or foam
- Boxes ship flat and ready to assemble

### Specifications

- B-flute corrugated board
- **Acid-free**, lignin-free
- 8.0-9.0 pH
- 3% calcium carbonate buffer
- **P. A. T. Certified**

### ACRYLIC COATED

| CAT.#             | H x W x D      | LBS. | PRICE          |
|-------------------|----------------|------|----------------|
| <b>49 529 002</b> | 5" x 12" x 10" | 1.30 | <b>\$32.26</b> |
| <b>49 529 004</b> | 5" x 20" x 16" | 1.60 | <b>45.26</b>   |

### UNCOATED

| CAT.#             | H x W x D                                    | LBS. | PRICE          |
|-------------------|--|------|----------------|
| <b>49 529 101</b> | 3" x 17 $\frac{1}{2}$ " x 11 $\frac{1}{2}$ " | 1.20 | <b>\$26.51</b> |
| <b>49 529 104</b> | 5" x 20" x 16"                               | 1.60 | <b>41.25</b>   |

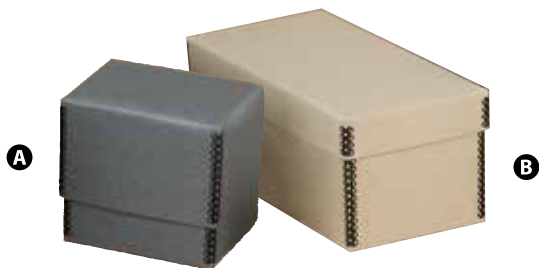

### Disc Storage Boxes

Metal edged for stacking

- Exposed serrated edge to reduce chance of injury
- Shrink-wrapped with polyethylene to preserve archival integrity
- 4½"D boxes hold up to 10 single CDs in jewel cases or 50 CDs in Tyvek® sleeves
- 12"D boxes hold up to 26 single CDs in jewel cases or 133 CDs in Tyvek® sleeves (sold separately)

#### Specifications

- 60-pt. tan, grey/white, or black barrier board
- Acid-free, lignin-free
- 8.0-9.0 pH
- 3% calcium carbonate buffer
- P.A.T. Certified

#### SafePack

| CAT.#      | DESCRIPTION               | H x W x D       | LBS. | PRICE   |
|------------|---------------------------|-----------------|------|---------|
| 38 374 001 | (A) Grey/White Hinged Lid | 5½" x 6" x 4½"  | 0.40 | \$15.16 |
| 38 374 100 | (B) Tan Two Piece Lid     | 5½" x 5½" x 12" | 0.65 | 49.38   |
| 38 374 200 | Black Two Piece Lid       | 5½" x 5½" x 12" | 0.65 | 56.07   |

### Dividers with Index Tabs

- 5"H x 5½"W buffered cream stock divider cards feature heavy-duty attached Mylar index tabs (two each red, blue, green, yellow, and orange)
- 10 cards per package

| CAT.#      | LBS. | PRICE   |
|------------|------|---------|
| 38 452 001 | 0.25 | \$29.13 |

### Microfilm Reels

Reels feature a 100' capacity and a flange that holds film firmly in place

- Acid-free, high-impact ABS plastic reels
- Offers safe storage for your expanding microfilm collection



| CAT.#      | DESCRIPTION           | LBS. | PRICE  | 50+    |
|------------|-----------------------|------|--------|--------|
| 83 095 001 | 16mm Open Flange Reel | 0.40 | \$2.48 | \$2.36 |
| 83 096 001 | 35mm Open Flange Reel | 0.50 | 4.47   | 4.25   |

#### Specifications

- 10-pt. buffered light tan PermaDur®
- Acid-free, lignin-free
- 8.5 pH
- P.A.T. Certified



### Microfilm Reel Loop and Button Reel ID Tags

Tags offer sufficient space for lettering and numbering

- Button loop prevents 35mm film from unraveling on the reel
- 100 tags per package

| CAT.#      | H x W     | LBS. | PRICE    |
|------------|-----------|------|----------|
| 49 086 001 | 1½" x 12" | 0.60 | \$272.62 |

### Shallow Lid Box



#### Specifications

- 40-pt. tan barrier board
- Acid-free, lignin-free
- 8.0-9.0 pH
- 3% calcium carbonate buffer
- P.A.T. Certified

### Microfiche Boxes

Tan barrier board boxes for 4" x 6" microfiche storage

- Exposed serrated edge to reduce chance of injury
- Shrink-wrapped with polyethylene to preserve archival integrity
- Large two-piece box with shallow lid safely stores up to (600) 4" x 6" fiche in envelopes
- Metal-reinforced edges for stacking strength and durability

#### SafePack

| CAT.#      | H x W x D       | LBS. | PRICE   |
|------------|-----------------|------|---------|
| 85 405 001 | 4¾" x 6¾" x 12" | 1.10 | \$40.44 |

### Microfiche Divider Guides

Safely divide and organize your fiche collection

- Acid-free, lignin-free dividers
- Choose full-cut or half-cut 20-pt. cream stock dividers
- 50 divider guides/separators per package
- P.A.T. Certified



| CAT.#      | DESCRIPTION                 | H x W    | LBS. | PRICE   |
|------------|-----------------------------|----------|------|---------|
| 49 080 001 | Full-Cut 20-pt. Cream Stock | 4¾" x 6" | 1.10 | \$34.15 |
| 49 080 002 | Half-Cut 20-pt. Cream Stock | 4¾" x 6" | 0.94 | 34.15   |

### High Throat Microfiche Envelopes

Seamed outside edges offer a smooth, abrasive-free surface

- Acid-free, lignin-free, buffered paper envelopes protect fiche from dust, dirt, and damage
- Envelopes fit easily into 4" x 6" microfiche box; 500 envelopes per package
- P.A.T. Certified



| CAT.#      | H x W     | PRICE    |
|------------|-----------|----------|
| 49 003 001 | 4¾" x 6¾" | \$127.45 |



## Specifications

- 60-pt. grey/white or black barrier board
- Acid-free, lignin-free
- 8.0-9.0 pH
- 3% calcium carbonate buffer
- P.A.T. Certified



## Phonograph Storage Boxes

Each box holds up to 45 records

- Exposed serrated edge to reduce chance of injury
- Shrink-wrapped with polyethylene to preserve archival integrity
- Long-term storage boxes keep fragile phonograph records safe from scratches and fingerprints
- Sturdy boxes and hinged flip-top lids feature metal-reinforced edges for stacking strength and durability
- For extra protection, place records in sleeves (sold separately below) before storing



### SafePack

| CAT.#      | HOLDS       | COLOUR     | H x W x D      | PRICE   |
|------------|-------------|------------|----------------|---------|
| 38 289 001 | 7" Records  | Grey/White | 8" x 7½" x 7"  | \$35.81 |
| 38 440 001 | 7" Records  | Black      | 8" x 7½" x 7"  | 47.46   |
| 38 384 001 | 12" Records | Grey/White | 13" x 13" x 6" | 38.59   |
| 38 384 002 | 12" Records | Black      | 13" x 13" x 6" | 51.77   |

## Record Storage Sleeves

Protect valuable records from fingerprints and damage

- 10-pt. cream folder stock sleeves
- Sleeves are acid-free and lignin-free
- pH level of 8.0-8.5; 3% calcium carbonate buffer
- Choose sleeves with die-cut centre opening (not shown) to display record label or sleeves with flap closure and no centre opening
- 25 sleeves per package
- P.A.T. Certified

### WITH CENTRE OPENING AND NO FLAP CLOSURE

| CAT.#      | H x W      | PRICE   |
|------------|------------|---------|
| 38 291 001 | 7" x 7"    | \$59.92 |
| 38 291 002 | 10" x 10½" | 66.49   |
| 38 291 003 | 12" x 12½" | 69.91   |

### WITH FLAP CLOSURE AND NO CENTRE OPENING

| CAT.#      | H x W     | PRICE   |
|------------|-----------|---------|
| 38 292 002 | 13" x 13" | \$80.55 |



## Drop-Front VHS Storage Boxes

Heavy-duty corrugated box features drop-front panel and hinged lid for easy access

- Exposed serrated edge to reduce chance of injury
- Shrink-wrapped with polyethylene to preserve archival integrity
- Choose acrylic-coated to repel moisture or uncoated

Ships flat and ready to assemble. (8"H x 4¾"W x 24"D) **SafePack**

## Specifications

- B-flute grey stone corrugated board
- Acid-free, lignin-free
- 8.0-9.0 pH
- 3% calcium carbonate buffer
- P.A.T. Certified

| CAT.#      | DESCRIPTION | LBS. | PRICE   |
|------------|-------------|------|---------|
| 32 378 001 | Coated      | 1.00 | \$34.07 |
| 32 378 101 | Uncoated    | 1.00 | 34.10   |

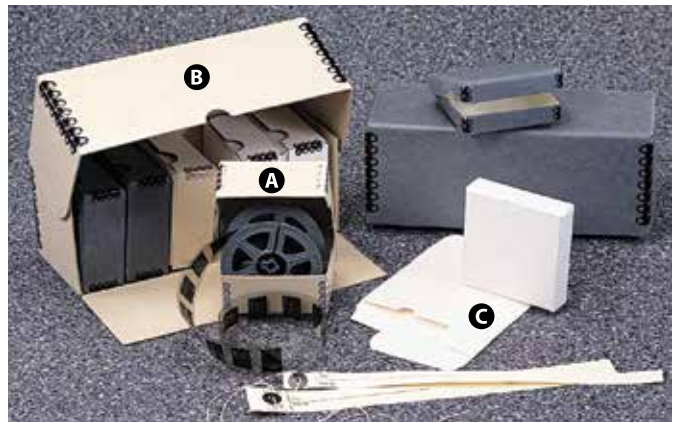

## Microfilm Storage Boxes

Protect 16mm and 35mm microfilm reels from dust, dirt, and damage during handling and storage

- Acid-free, lignin-free, buffered board stock boxes
- All boxes except (C) "Pop-Up" box feature metal edges for added stacking strength and durability
- P.A.T. Certified

### (A) MICROFILM INDIVIDUAL HINGED LID STORAGE BOXES

- 35mm box measures 1½"H x 3¾"W x 3¾"D
- 16mm box measures 3/4"H x 3¾"W x 3¾"D

| CAT.#      | DESCRIPTION   | LBS. | PRICE   |
|------------|---|------|---------|
| 38 437 001 | 40-pt. Tan Board for 35mm                           | 0.12 | \$14.73 |
| 38 437 202 | 60-pt. White Board with Blue/Grey Interior for 16mm | 0.07 | 13.97   |

### (B) MICROFILM STORAGE CASES

- 10½"D case stores six 35mm boxes or eleven 16mm boxes
- 14¾"D case stores eight 35mm boxes

| CAT.#      | DESCRIPTION            | H x W x D        | LBS. | PRICE   |
|------------|------------------------|------------------|------|---------|
| 39 502 101 | 60-pt. Blue/Grey Board | 4½" x 4¾" x 10½" | 0.40 | \$18.33 |
| 39 502 102 | 60-pt. Blue/Grey Board | 4¾" x 4¾" x 14¾" | 0.40 | 20.02   |

### (C) ECONOMY MICROFILM REEL "POP-UP" BOX

- White buffered archival board with pH of 8.5
- Ships flat and "pops up" for easy assembly; 100 per package

| CAT.#      | DESCRIPTION     | LBS. | PRICE    |
|------------|-----------------|------|----------|
| 38 996 001 | Holds 35mm Film | 5.90 | \$261.35 |

## Specifications

- 60-pt. grey/white barrier board
- Acid-free, lignin-free
- 8.0-9.0 pH
- 3% calcium carbonate buffer
- P.A.T. Certified



## VHS and Audiocassette Storage Boxes

Two-piece grey/white storage boxes feature metal-reinforced edges that add stacking strength and durability for long-term storage

- Exposed serrated edge to reduce chance of injury
- Shrink-wrapped with polyethylene to preserve archival integrity
- VHS Box has a shallow lid to protect up to 12 videocassettes in their original cases
- Audiocassette Box has a deep telescoping lid to protect up to 36 audiocassettes from dirt and dust

### SafePack

| CAT.#      | DESCRIPTION               | H x W x D       | LBS. | PRICE   |
|------------|---------------------------|-----------------|------|---------|
| 32 396 001 | VHS Storage Box           | 5" x 15½" x 8½" | 1.01 | \$50.06 |
| 32 376 001 | Audiocassette Storage Box | 3" x 12½" x 9½" | 0.96 | 32.69   |



Two Ten-Drawer Flat Files with optional Closed Base

One Medium Five-Drawer Flat File with optional Open Base



**Steel Flat Files**

Safely store maps, blueprints, building plans, or documents

- Archival-safe secure files with heavy-gauge steel frames and front supports
- Stackable up to five high on closed base
- Anti-slip pads keep files in place when stacked
- Drawers feature extra-strength rails, heavy steel side roller assembly, and steel ball-bearing rollers for smooth operation without jamming
- Drawers include label holders and chrome handles
- Safety stop prevents drawers from being pulled out
- Front depressors prevent sheets of paper from curling
- Five-drawer file has 2"H drawers; 10-drawer file has 1"H drawers
- Call for custom colours (upcharge)

Assembled. Ships from manufacturer via truck.

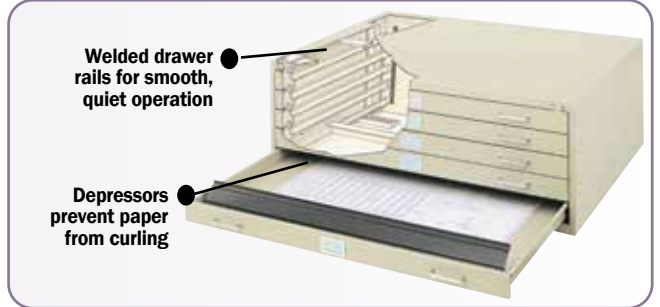

Welded drawer rails for smooth, quiet operation

Depressors prevent paper from curling

**SMALL FIVE-DRAWER FLAT FILE**

Overall dimensions: 16½"H x 40¾"W x 29¾"D.  
Inside drawer dimensions: 2¾"H x 37"W x 26"D.

| CAT.#       | DESCRIPTION     | LBS.   | PRICE      |
|-------------|-----------------|--------|------------|
| 87 100 000* | Small Flat File | 160.00 | \$3,484.00 |
| 87 102 000* | 6"H Closed Base | 22.00  | 609.00     |
| 87 103 000* | 20"H Open Base  | 39.00  | 1,309.98   |

\*Specify colour below.

**MEDIUM FIVE-DRAWER FLAT FILE**

Overall dimensions: 16½"H x 46¾"W x 35¾"D.  
Inside drawer dimensions: 2¾"H x 43"W x 32"D.

| CAT.#       | DESCRIPTION      | LBS.   | PRICE      |
|-------------|------------------|--------|------------|
| 87 105 000* | Medium Flat File | 195.00 | \$4,029.00 |
| 87 107 000* | 6"H Closed Base  | 26.00  | 653.00     |
| 87 108 000* | 20"H Open Base   | 43.00  | 1,423.00   |

\*Specify colour below.

**LARGE FIVE-DRAWER FLAT FILE**

Overall dimensions: 16½"H x 53½"W x 41½"D.  
Inside drawer dimensions: 2¾"H x 50"W x 38"D.

| CAT.#       | DESCRIPTION     | LBS.   | PRICE      |
|-------------|-----------------|--------|------------|
| 87 110 000* | Large Flat File | 250.00 | \$4,770.00 |
| 87 112 000* | 6"H Closed Base | 30.00  | 817.00     |
| 87 113 000* | 20"H Open Base  | 48.00  | 1,483.00   |

\*Specify colour below.

**TEN-DRAWER FLAT FILE**

Overall dimensions: 16½"H x 46¾"W x 35¾"D.  
Inside drawer dimensions: 1¾"H x 43"W x 32"D.

| CAT.#       | DESCRIPTION                        | LBS.   | PRICE      |
|-------------|------------------------------------|--------|------------|
| 87 133 000* | Flat File (not available in White) | 278.00 | \$7,118.00 |
| 87 107 000* | 6"H Closed Base                    | 26.00  | 653.00     |
| 87 108 000* | 20"H Open Base                     | 43.00  | 1,423.00   |

\*Specify colour below.

**LOCK KIT** - For extra security. (1.00 lb.)

| CAT.#      | DRAWERS | PRICE    |
|------------|---------|----------|
| 87 115 004 | 5       | \$206.00 |
| 87 115 005 | 10      | 206.00   |

**STANDARD COLOURS:**



**CUSTOM COLOURS; CALL FOR PRICING:**

